





MANUFACTURING AMERICAN PRIDE

As the industry leader in golf cart lift kits and accessories, All Sports sets the standard for the innovation and fabrication of the highest quality aftermarket products.

We specialize in custom fabrication, and tailor our products to fit the most popular brands of carts. In addition to stainless steel, diamond plate and brushed aluminum finishes, we will custom powder coat any product — including lift kits — with our in-house powder coating system to meet your color specifications.

ELEVATING THE STANDARD OF EXCELLENCE

When you purchase any product from All Sports, you deal directly with the manufacturer. We're so confident in the quality of our products that we offer a 100% Buy Back Guarantee, along with next day or same day shipping.

WE LOVE OUR DEALERS

At All Sports, our primary goal is to be your Golf Cart Lift Kit & Accessories Distributor, not your competition. We want to help you grow your business, keep your stores stocked, and provide you with the products your customers want. Excellent customer service will not be compromised! When you call us during business hours, a live person will always answer the phone, not a machine. Our staff is here to offer you personalized, high-quality service! Have a question and don't see the answer here? Give us a call at (866) 291-5244 and one of our representatives will be happy to assist you!

We look forward to doing business with you!

-ALL SPORTS MANUFACTURING, INC.

SHIPPING

Most in-stock items are shipped same or next day of order placement. Check UPS Delivery Times & Charges, or Fed Ex maps. Free Shipping applies only to orders of \$2,500 or more and only includes the continental United States.

PRICING

Due to the large amount of products we carry, some prices may not be up to date. In the event of a price/photo change, we reserve the right to correct any error.

RETURNS

For assistance with a return, please call one of our representatives. All returns must be accompanied by an RMA#. Do not throw away any of the original packaging, even if it is damaged.

Address all packages to:
3361 Copter Rd.
Pensacola, FL 32514

HOURS

Open Monday - Friday
8:00AM - 4:30PM CST

CALL US TO ORDER

TOLL FREE: (866) 291-5244
LOCAL: (850) 477-5244

TABLE OF CONTENTS

LIFT KITS	4	BRUSH GUARDS	30
CLUB CAR	5	NERF BARS, STEPS, & BUMPERS	35
PRECEDENT	5	NERF BARS & STEPS	36
DS	6	BUMPERS	39
E-Z-GO	9	LIGHT KITS & MIRRORS	41
TXT	9	HITCHES	43
MARATHON	10	TIRES & WHEELS	46
WORKHORSE	11	TIRES	47
RXV	12	WHEELS	49
YAMAHA	13	TIRE & WHEEL ACCESSORIES	52
G1, G2, G9, G14,		TIRE & WHEEL KITS	52
G16, G19, & G22	13	MORE ACCESSORIES	55
DRIVE	14	WINDSHIELDS	56
LONG TRAVEL LIFT KITS	15	FENDER FLARES	57
CUSTOM POWDER COATING	17	DASHES	58
SEAT KITS	18	SEAT BELTS	58
SEAT KITS	19	STEERING WHEELS &	
FRONT SEAT COVERS	20	STEERING ACCESSORIES	59
CLUB CAR PRECEDENT	20	ENCLOSURES & COVERS	62
CLUB CAR DS	21	OTHER ACCESSORIES	62
E-Z-GO TXT/RXV	22	BATTERIES & MAINTENANCE	71
YAMAHA DRIVE	23	BATTERIES & BRAKES	72
SEAT KIT REAR CUSHIONS	24	BALL JOINTS, BUSHINGS,	
SEAT KIT ACCESSORIES	25	& HARDWARE	74
CARGO & STORAGE	26	REPLACEMENT PARTS	75



LIFT KITS

CLUB CAR® LIFT KITS

From our 3" A-Arm to the massive 11" Ultra, the largest production kit available, our Club Car® lift kits are a must for any golf cart accessory distributor. They offer flexibility and greater clearance, and feature easy bolt-on installation — no cutting or welding required! Best of all, they're American-made and Club Car® approved.

PRECEDENT

PRECEDENT A-ARM LIFT KITS



- Cutting Edge A-Arm Design
- No Cutting or Welding Required
- Lengthens Wheel Base
- Adjustable Toe & Camber
- Must use 10" Wheels
- Heavy Duty 4 UBolt Rear End Setup
- 1/2" Ball Joints

3" A-ARM LIFT KIT

Part# ASM-P3A — Max. Tire Size: 20 x 11 - 10

4" A-ARM LIFT KIT

Part# ASM-P4A — Max. Tire Size: 22 x 11 - 12

6" A-ARM LIFT KIT (Pictured)

Part# ASM-P6A — Max. Tire Size: 23 x 10.5 - 14

PRECEDENT HEAVY DUTY LIFT KIT



- Cutting Edge A-Arm Design
- No Cutting or Welding Required
- Lengthens Wheel Base
- Adjustable Toe & Camber
- Must use 10" Wheels
- Heavy Duty 4 UBolt Rear End Setup
- 5/8" Ball Joints

Part# ASM-P3AHD — 3" Heavy Duty A-Arm Lift Kit

Part# ASM-P6AHD — 6" Heavy Duty A-Arm Lift Kit (Pictured)

11" ULTRA ELECTRIC LIFT KIT

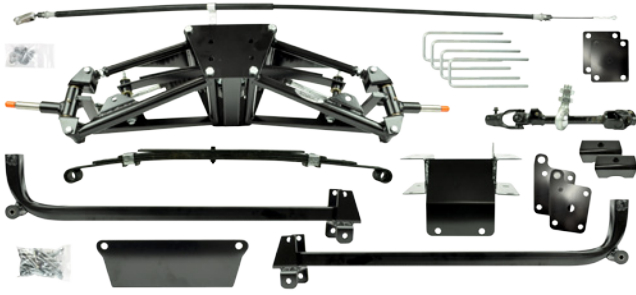

- Be the talk of the town! The largest lift kit available! No cutting or welding required!
- Will accommodate up to 28" Tires

Part# ASM-P11UE

1/2" BLOCK LIFT



- Stops Cart from Rubbing in Turns
- Simple Installation
- Front Lift Only
- Designed for Low Profile Tires & Wheels

Part# ASM-P12BL

CLUB CAR DS

DS A-ARM LIFT KITS

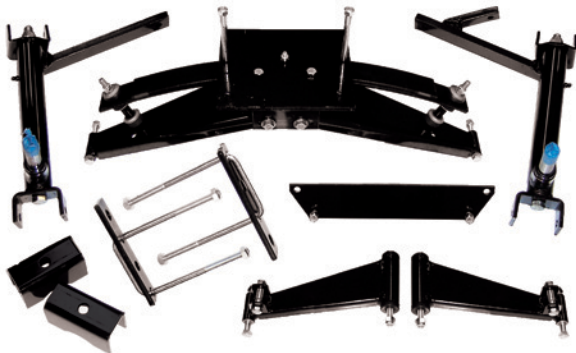

- Easy Bolt-On Installation
- True Independent A-Arm Suspension
- Lengthens Wheel Base
- Adjustable Toe & Camber
- No Cutting or Welding Required
- ATV Design and Durability
- 2 Bolt Rear Set Up

4" A-ARM LIFT KIT — Tire Size: 22 x 10.5 - 10

Part# ASM-C4AP97 — Pre-1997 Gas

Part# ASM-C4A — Standard (1997 - 2003.5)

Part# ASM-C4ANS — N/S Metric (2003.5 - Present)

6" A-ARM LIFT KIT — Tire Size: 23 x 11 - 12

Part# ASM-C6AP97 — Pre-1997 Gas

Part# ASM-C6A — Standard (1997 - 2003.5)

Part# ASM-C6ANS — N/S Metric (2003.5 - Present)

8" A-ARM LIFT KIT — Tire Size: 26 x 12 - 14

Part# ASM-C8AP97 — Pre-1997 Gas

Part# ASM-C8A — Standard (1997 - 2003.5); Heavy Duty Springs Included

Part# ASM-C8ANS — N/S Metric (2003.5 - Present); Heavy Duty Springs Included

DS SUPER SPORT LIFT KITS



- Easy Bolt-On Installation
- True Independent A-Arm Suspension
- Fully Adjustable Toe & Camber
- No Cutting or Welding Required
- Heavy Duty 4 UBolt Rear End Setup
- ATV Design & Durability
- All Mounting Hardware Included
- 5/8" Ball Joints

4" SUPER SPORT LIFT KIT — Tire Size: 23 x 10 - 12

Part# ASM-C4SSP97 — Pre-1997 Gas

Part# ASM-C4SS — Standard (1997 - 2003.5)

Part# ASM-C4SSNS — N/S Metric (2003.5 - Present)

6" SUPER SPORT LIFT KIT — Tire Size: 24 x 11 - 14

Part# ASM-C6SSP97 — Pre-1997 Gas

Part# ASM-C6SS — Standard (1997 - 2003.5)

Part# ASM-C6SSNS — N/S Metric (2003.5 - Present)

7.5" SUPER SPORT LIFT KIT — Tire Size: 26 x 10 - 14; Heavy Duty Springs Included

Part# ASM-C75SSP97 — Pre-1997 Gas

Part# ASM-C75SS — Standard (1997 - 2003.5)

Part# ASM-C75SSNS — N/S Metric (2003.5 - Present)

1" BLOCK LIFT



- Clearance from Rubbing
- Fits DS Models 1982 - Present
- Front Lift Only
- For Low Profile Tires & Wheels 10" or Larger

Part# ASM-C1BL

DS 10" ULTRA LIFT KIT



- Fully Adjustable Toe & Camber
- Tubular A-Arm Design

- Gas Models require slight modification to Engine Carrier
- Tire Size: 28 x 12 - 14

PRE-1997

Part# ASM-C10AGP97 — Gas

STANDARD (1997-2003.5)

Part# ASM-C10AG — Gas

Part# ASM-C10AE — Electric

NEW STYLE - METRIC (2003.5-Present)

Part# ASM-C10AG — Gas

Part# ASM-C10AE — Electric

2003 & NEWER DS AND CLUB CAR CARRYALL



Check your dust cap covers!

E-Z-GO® LIFT KITS

A trusted name in golf carts, E-Z-GO® strives to offer an unparalleled combination of quality, state-of-the-art products, expertly built and coupled with unbeatable service. Our E-Z-GO® lifts are E-Z-GO® approved, and meet this same high standard.

TXT 2001 - PRESENT

TXT DROP AXLE LIFT KIT w/ SPINDLES

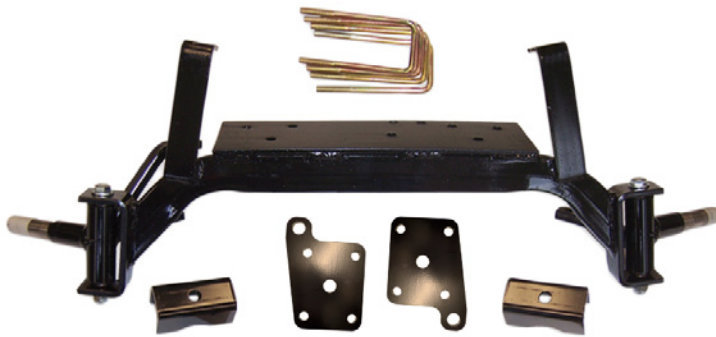

- Replaces OEM Axle
- Easy Bolt-On Installation
- All Mounting Hardware Included
- Electric 4" Pictured
- 5" Includes Shock Stud Extensions & Rear Shackles

4" DROP AXLE LIFT KIT w/ SPINDLES — Tire Size: 22 x 11 - 12

Part# ASM-E4NSG — Gas

Part# ASM-E4NSE — Electric

5" DROP AXLE LIFT KIT w/ SPINDLES — Tire Size: 23 x 10.5 - 14

Part# ASM-E5NSG — Gas

Part# ASM-E5NSE — Electric

TXT LIFT KIT w/ SPINDLES



- Replaces OEM Spindles
- Easy Bolt-On Installation
- All Mounting Hardware Included
- 6" Includes Shock Stud Extensions & Rear Shackles

4" LIFT KIT w/ SPINDLES — Max. Tire Size: 22 x 11 - 12

Part# ASM-E4SG — Gas

Part# ASM-E4SE — Electric

6" LIFT KIT w/ SPINDLES (Pictured) — Tire Size: 23 x 10.5 - 14

Part# ASM-E6SG — Gas

Part# ASM-E6SE — Electric

TXT 1994 - MID 2001

HIGH FIVE 5" TXT LIFT KIT

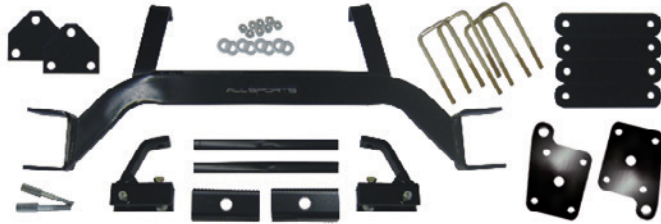

- Heavy Duty Springs Recommended
- Lengthens Wheel Base
- Creates Wider Stance
- Tire Size: 27 x 10.5 - 14

Part# ASM-H5G — Gas

Part# ASM-H5E — Electric

TXT DROP AXLE LIFT KIT ('94 - '00)

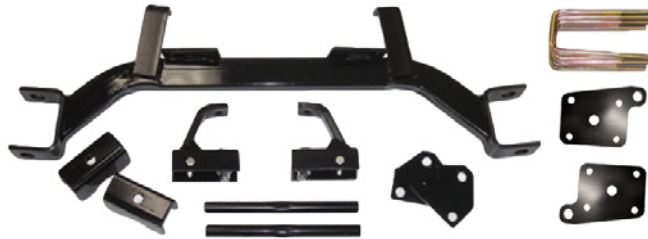

- Adjustable Toe
- Replaces OEM Axle
- Easy Bolt-On Installation
- No Cutting or Welding Required
- 3" Lift Shown

3" DROP AXLE LIFT KIT — Tire Size: 22 x 11 - 10

Part# ASM-E3G — Gas

Part# ASM-E3E — Electric

5" DROP AXLE LIFT KIT — Tire Size: 23 x 10.5 - 14

Part# ASM-E5G — Gas; Shock Stud Extensions & Rear Shackles Included

Part# ASM-E5E — Electric; Shock Stud Extensions & Rear Shackles Included

MARATHON 1979 - 1993

4" MARATHON BLOCK LIFT KIT



- Easy Bolt-On Installation
- No Cutting or Welding Required
- All Mounting Hardware Included
- Gas (Left) and Electric (Right) Pictured
- Max. Tire Size: 20"

Part# ASM-M4G — Gas

Part# ASM-M4E — Electric

WORKHORSE 2001 - PRESENT

1200 SERIES 4" OR 5" LIFT KIT



- 4" or 5" Gas Lift
- Adjustable Toe
- Replaces OEM Axle
- No Cutting or Welding Required
- Easy Bolt-On Installation
- All Hardware Included

Part# ASM-WH401 — 4" Gas Lift; Tire Size: 22 x 11 - 12

Part# ASM-WH501 — 5" Gas Lift; Tire Size: 23 x 10.5 - 14

WORKHORSE 1994 - MID 2001

1200 SERIES 3" OR 5" LIFT KIT



- 3" or 5" Gas Lift
- Adjustable Toe
- Replaces OEM Axle
- No Cutting or Welding Required
- Easy Bolt-On Installation
- All Hardware Included

Part# ASM-WH3 — 3" Lift; Tire Size: 22 x 11 - 8

Part# ASM-WH5 — 5" Lift; Tire Size: 23 x 10.5 - 14

RXV

2.5" RXV SPINDLE LIFT



- Easy Bolt-On Installation
- All Hardware Included
- Tire Size: 22 x 11 - 10

Part# ASM-RXV2.5 — 2012 & Older

Part# ASM-RXV2.52013+ — 2013 & Newer

6" RXV SPINDLE LIFT



- Easy Bolt-On Installation - Installs in Minutes!
- No Cutting or Welding Required
- Tire Size: 23 x 10 - 14
- Must use 10" or 12" Wheels

Part# ASM-RXV6S — 2012 & Older; Fits Gas & Electric

Part# ASM-RXV6SE2013+ — 2013 & Newer

4" RXV CARRIER LIFT KIT



- Rear Lift Centers Wheels
- Increases Track Width by 2"
- Easy Bolt-On Installation
- No Cutting or Welding Required
- Compatible with All RXV's
- Tire Size: 23 x 10.5 - 12

Part# ASM-RXV4CG — Gas

Part# ASM-RXV4CE — Electric

YAMAHA® LIFT KITS

Yamaha® has always been a name synonymous with quality craftsmanship. These lift kits follow that tradition by using quality materials and precision assembly. Compliment your product line with All Sports lift kits!

4" G1 LIFT KIT

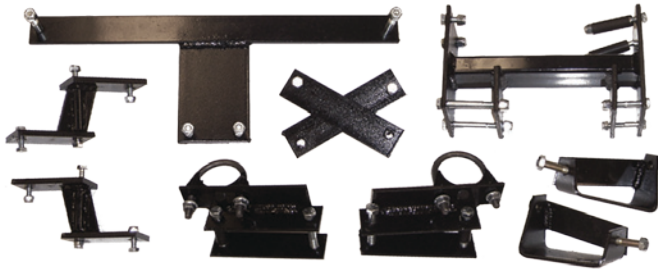

- Easy Bolt-On Installation
- No Cutting or Welding Required
- Fits Gas & Electric
- Tire Size: 20 x 11 - 10

Part# ASM-Y1

7" G2/G9 A-ARM LIFT KIT



- Fits Gas & Electric
- Easy Bolt-On Installation
- No Cutting or Welding Required
- Tire Size: 23 x 11 - 14

Part# ASM-Y29

7" G14/G16/G19 A-ARM LIFT KIT

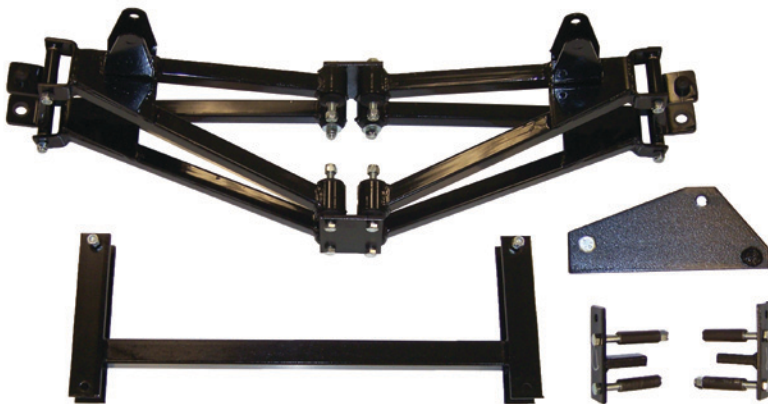

- Fits Gas & Electric
- Easy Bolt-On Installation
- No Cutting or Welding Required
- Tire Size: 23 x 11 - 14

Part# ASM-Y469

6" G22 G-MAX LIFT KIT



- Only G-Max Kit Available w/ Adjustable Camber
- Fits Gas & Electric
- Easy Bolt-On Installation
- No Cutting or Welding Required
- Tire Size: 23 x 10.5 - 14

Part# ASM-Y22

DRIVE

DRIVE SPINDLE LIFT KIT



- Fits Yamaha Drive Models
- Easy Bolt-On Installation
- No Cutting or Welding Required

1" SPINDLE LIFT KIT — Great for low profile tires!

Part# ASM-Y1DSL

3" SPINDLE LIFT KIT — Tire Size: 22 x 11 - 10

Part# ASM-Y3DSL

6" SPINDLE LIFT KIT — Tire Size: 23 x 11 - 14

Part# ASM-Y6DSL

6" DRIVE A-ARM LIFT KIT



- Fits Yamaha Drive Models
- Also Available for Drive 2
- New Front Shocks
- Fits Gas & Electric
- Easy Bolt-On Installation
- No Cutting or Welding Required
- Adjustable Toe & Camber
- Tire Size: 23 x 10 - 14

Part# ASM-YD6A

LONG TRAVEL LIFT KITS

With its tight turning radius and ultra narrow track width, the Long Travel is the Cadillac of lift kits. Built using Progressive Suspension™ 512 Series Shocks, 5/8" Teflon-Lined Ball Joints, and diamond plate skid plates, our long travel lift kits are made with ATV design and durability.

**Long travels require an extra 7-10 days processing time to ensure maximum quality.*

CLUB CAR PRECEDENT LONG TRAVEL LIFT KIT

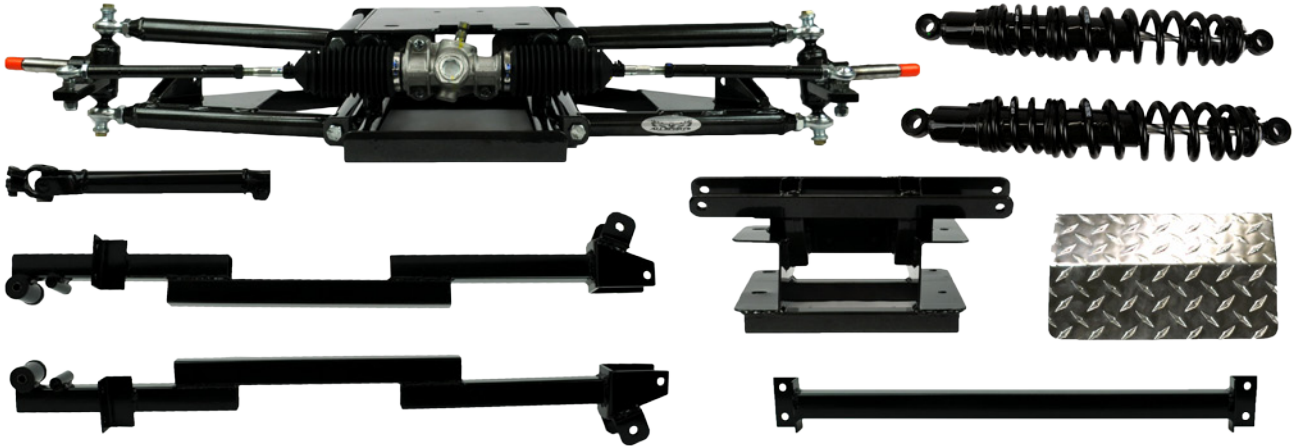

- Fully Adjustable Coil Over Shocks
- Club Car Inc. Steering Box
- True Independent A-Arm Suspension
- Heavy Duty 4 UBolt Rear End Setup

6" LONG TRAVEL LIFT KIT — Tire Size: 25 x 11 - 14

Part# ASM-P6LT — 6" Lift Kit

8" LONG TRAVEL LIFT KIT — Tire Size: 28 x 11 - 14

Part# ASM-P8LT — 8" Lift Kit

6" CLUB CAR DS LONG TRAVEL LIFT KIT



- Fully Adjustable Coil Over Shocks
- Club Car Inc. Steering Box
- True Independent A-Arm Suspension
- Fully Adjustable Toe & Camber
- Easy Bolt-On Installation
- No Cutting or Welding Required
- Tire Size: 25 x 10.5 - 14

Part# ASM-C6LTP97 — Pre-1997

Part# ASM-C6LT — Standard (1997 - 2003.5)

Part# ASM-C6LTNS — N/S (2003.5 - Present)

E-Z-GO TXT LONG TRAVEL LIFT KITS



- Fully Adjustable Coil Over Shocks
- True Independent A-Arm Suspension
- Fully Adjustable Toe & Camber
- Heavy Duty 4 UBolt Rear End Setup
- Easy Bolt-On Installation
- No Cutting or Welding Required

6" LONG TRAVEL: OLD STYLE (1994-2000) — Tire Size: 25 x 11 - 14

Part# ASM-E6LTG — Gas; Includes New Hubs & Steering Column

Part# ASM-E6LTE — Electric; Includes New Hubs & Steering Column

6" LONG TRAVEL: NEW STYLE (2001 - PRESENT) — Tire Size: 25 x 11 - 14

Part# ASM-E6LTNSG — Gas

Part# ASM-E6LTNSE — Electric

8" LONG TRAVEL: OLD STYLE (1994-2000) — Tire Size: 28 x 12 - 14

Part# ASM-E8LTG — Gas; Includes New Hubs & Steering Column

Part# ASM-E8LTE — Electric; Includes New Hubs & Steering Column

8" LONG TRAVEL: NEW STYLE (2001 - PRESENT) — Tire Size: 25 x 11 - 14

Part# ASM-E8LTNSG — Gas

Part# ASM-E8LTNSE — Electric

6" YAMAHA LONG TRAVEL LIFT KIT

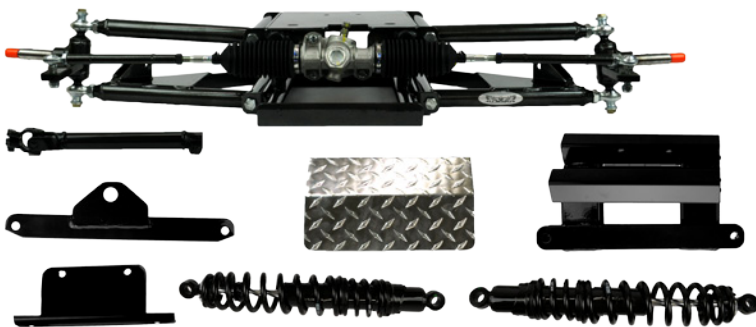

- Fully Adjustable Coil Over Shocks
- True Independent A-Arm Suspension
- Fully Adjustable Toe & Camber
- Heavy Duty 4 UBolt Rear End Setup
- Easy Bolt-On Installation
- Tire Size: 25 x 11 - 10

Part# ASM-Y6DLT — Yamaha Drive

Part# ASM-Y6LT22 — Yamaha G22

CUSTOM POWDER COATING

Whether it's supporting their team, strengthening their corporate identity, or just showing off their own unique style, our powder coating colors will make your customers' carts one of a kind! We powder coat lift kits, nerf bars, and other accessories in-house. Don't see the color you're looking for? We can help you! Call us today to talk about special orders!

CLASSIC POWDER COATING COLORS

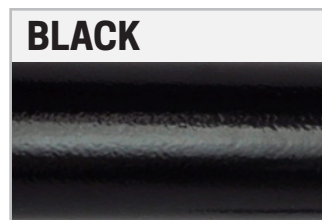

TRUILLUSION POWDER COATING COLORS





SEAT KITS & ACCESSORIES

SEAT KITS



- Upgraded Custom Colored Cushions Available
- Beautiful Powder-Coated Finish
- Stainless Steel Hardware
- Available in 100% Aluminum
- E-Z-GO RXV Seat Kit w/ OEM Tan Cushion Pictured

*NOTE: Colors pictured are for illustrative purposes only. Actual cushion color may vary.
Camo available for a small upcharge

OEM COLORS



CARBON STEEL SEAT KIT w/ ALUMINUM STEP PLATE

Part# ASM-PSK — Club Car Precedent; Top supports included.

Part# ASM-CSK — Club Car DS; 2000.5 Models and Newer

Part# ASM-CSKOS — Club Car DS; 2000.5 Models and Older; Top supports included

Part# ASM-ESK — E-Z-GO TXT

Part# ASM-RXVSK — E-Z-GO RXV

Part# ASM-YSK — Yamaha G14-G19; Top supports included.

Part# ASM-YSK22 — Yamaha G22

Part# ASM-YSKDRIVE — Yamaha Drive

Part# ASM-YSKDRIVE2 — Yamaha Drive 2

100% ALUMINUM

Part# ASM-PSKA — Club Car Precedent; Top supports included.

Part# ASM-CSKA — Club Car DS; 2000.5 Models and Newer

Part# ASM-CSKOS — Club Car DS; 2000.5 Models and Older; Top supports included

Part# ASM-ESKA — E-Z-GO TXT

Part# ASM-RXVSKA — E-Z-GO RXV

Part# ASM-YSKA — Yamaha G14-G19; Top supports included.

Part# ASM-YSK22A — Yamaha G22

Part# ASM-YSKDRIVEA — Yamaha Drive

Part# ASM-YSKDRIVE2A — Yamaha Drive 2

CLUB CAR PRECEDENT FRONT SEAT COVERS

NOTE: Colors pictured are a representation of actual swatch. Texture/tones are not pictured. All Sports Manufacturing, Inc. is not liable for incorrect colors. Sample swatches are available upon request.

VICTORY



**SILVER & BLACK
CARBON FIBER**

Part# ASM-PSCVSCF



**DAREDEVIL RED
& BLACK**

Part# ASM-PSCVR



**SUNSET ORANGE
& BLACK**

Part# ASM-PSCVO



WHITE & BLACK

Part# ASM-PSCVW



ALL SADDLE

Part# ASM-PSCVSA

EDGE

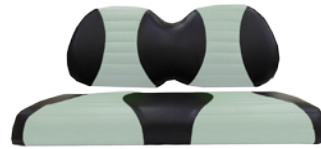

**SILVER & BLACK
THERMAL PLEAT**

Part# ASM-PSCEST



**DAREDEVIL RED
& BLACK
THERMAL PLEAT**

Part# ASM-PSCERT



**PARAKEET
GREEN & BLACK
THERMAL PLEAT**

Part# ASM-PSCEGNT

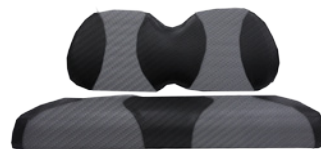

**GREY & BLACK
CARBON FIBER**

Part# ASM-PSCEGCF

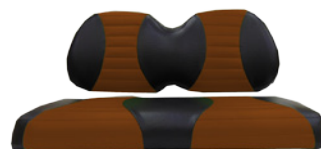

**SADDLE & BLACK
THERMAL PLEAT**

Part# ASM-PSCESAT

CLUB CAR DS FRONT SEAT COVERS

NOTE: Colors pictured are a representation of actual swatch. Texture/tone are not pictured. All Sports Manufacturing, Inc. is not liable for incorrect colors. Sample swatches are available upon request.

VICTORY



**SILVER & BLACK
CARBON FIBER**

Part# ASM-CSCVSCF



**DAREDEVIL RED
& BLACK**

Part# ASM-CSCVR



**SUNSET ORANGE
& BLACK**

Part# ASM-CSCVO



WHITE & BLACK

Part# ASM-CSCVW



ALL SADDLE

Part# ASM-CSCVSA

EDGE

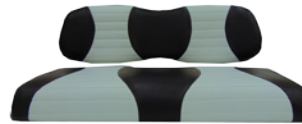

**SILVER & BLACK
THERMAL PLEAT**

Part# ASM-CSCEST



**DAREDEVIL RED
& BLACK
THERMAL PLEAT**

Part# ASM-CSCERT



**PARAKEET
GREEN & BLACK
THERMAL PLEAT**

Part# ASM-CSCEGNT

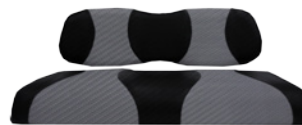

**GREY & BLACK
CARBON FIBER**

Part# ASM-CSCEGCF



**SADDLE & BLACK
THERMAL PLEAT**

Part# ASM-CSCESAT

E-Z-GO TXT/RXV FRONT SEAT COVERS

NOTE: Colors pictured are a representation of actual swatch. Texture/tones are not pictured. All Sports Manufacturing, Inc. is not liable for incorrect colors. Sample swatches are available upon request.

VICTORY



**SILVER & BLACK
CARBON FIBER**

Part# ASM-ESCVSCF



**DAREDEVIL RED
& BLACK**

Part# ASM-ESCVR



**SUNSET ORANGE
& BLACK**

Part# ASM-PSCVO



WHITE & BLACK

Part# ASM-ESCVW



ALL SADDLE

Part# ASM-ESCVSA

EDGE

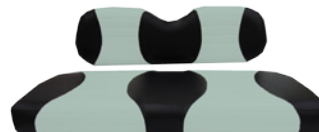

**SILVER & BLACK
THERMAL PLEAT**

Part# ASM-ESCEST



**DAREDEVIL RED
& BLACK
THERMAL PLEAT**

Part# ASM-ESCERT



**PARAKEET
GREEN & BLACK
THERMAL PLEAT**

Part# ASM-ESCEGNT

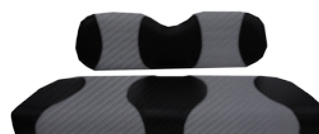

**GREY & BLACK
CARBON FIBER**

Part# ASM-ESCEGCF



**SADDLE & BLACK
THERMAL PLEAT**

Part# ASM-ESCESAT

YAMAHA DRIVE FRONT SEAT COVERS

NOTE: Colors pictured are a representation of actual swatch. Texture/tones are not pictured. All Sports Manufacturing, Inc. is not liable for incorrect colors. Sample swatches are available upon request.

VICTORY



**SILVER & BLACK
CARBON FIBER**

Part# ASM-DRSCVSCF



**DAREDEVIL RED
& BLACK**

Part# ASM-DRSCVR



**SUNSET ORANGE
& BLACK**

Part# ASM-DRSCVO



WHITE & BLACK

Part# ASM-DRSCVW

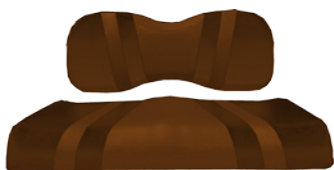

ALL SADDLE

Part# ASM-DRSCVSA

EDGE

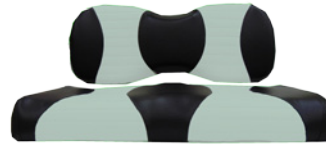

**SILVER & BLACK
THERMAL PLEAT**

Part# ASM-DRSCEST

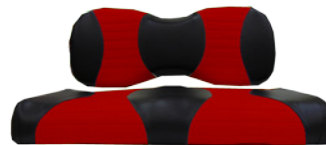

**DAREDEVIL RED
& BLACK
THERMAL PLEAT**

Part# ASM-DRSCERT



**PARAKEET
GREEN & BLACK
THERMAL PLEAT**

Part# ASM-DRSCEGNT



**GREY & BLACK
CARBON FIBER**

Part# ASM-DRSCEGCF



**SADDLE & BLACK
THERMAL PLEAT**

Part# ASM-DRSCESAT

SEAT KIT REAR CUSHIONS

NOTE: Colors pictured are a representation of actual swatch. Texture/tone are not pictured. All Sports Manufacturing, Inc. is not liable for incorrect colors. Sample swatches are available upon request.

VICTORY



**SILVER & BLACK
CARBON FIBER**

Part# ASM-SKVSCF



**DAREDEVIL RED
& BLACK**

Part# ASM-SKVR



**SUNSET ORANGE
& BLACK**

Part# ASM-SKVO



WHITE & BLACK

Part# ASM-SKVW



ALL SADDLE

Part# ASM-SKVSA

EDGE

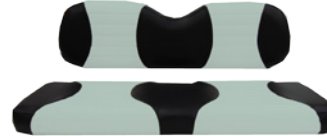

**SILVER & BLACK
THERMAL PLEAT**

Part# ASM-SKEST



**DAREDEVIL RED
& BLACK
THERMAL PLEAT**

Part# ASM-SKERT



**PARAKEET
GREEN & BLACK
THERMAL PLEAT**

Part# ASM-SKEGNT



**GREY & BLACK
CARBON FIBER**

Part# ASM-SKEGCF



**SADDLE & BLACK
THERMAL PLEAT**

Part# ASM-SKESAT

EASY STEP



- Aluminum Step Helps Rear Passengers Onto Cart
- Available in Textured Black; Satin Finish Also Available

Part# ASM-SKES

SEAT KIT ROLL BAR



- For ornamental use only
- BLACK** — Textured or Satin

Part# ASM-SKRBB

STAINLESS

Part# ASM-SKRBS

SEAT KIT HITCH



- Available in Black

Part# ASM-SKH

SEAT KIT HITCH ASSEMBLY



- Available in Black

Part# ASM-SKHA

SEAT KIT SAFETY BAR



- Available in Satin or Textured Black

Part# ASM-SKSB

EXTENDED ROOF SUPPORT

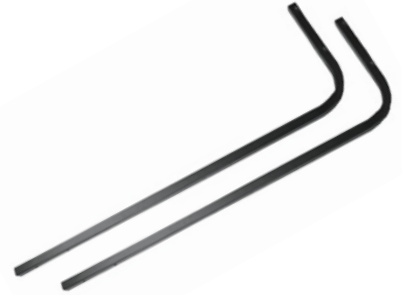

- Allows use of longer roof
- Available in Satin or Textured Black

Part# ASM-EXRS

GOLF BAG ATTACHMENT



- Available in Black

Part# ASM-SKGBA

CARGO SUPPORT



- Increases carrying capacity by 100 lbs.
- Weight limit should not exceed 300 lbs.

Part# ASM-SKCSB

FRONT REPLACEMENT SEATS



- Club Car DS Pictured Above
- Seats Vary by Model

Call for Pricing



CARGO & STORAGE

CLAYS BASKET



- 80 lb Carrying Capacity
- Works with Fold-Down Windshield
- Mounting Hardware Included
- Available in Textured or Satin

Part# ASM-PCB — Club Car Precedent

Part# ASM-CCB — Club Car DS

Part# ASM-ECB — E-Z-GO TXT

Part# ASM-RXVCB — E-Z-GO RXV

Part# ASM-WCB — E-Z-GO Workhorse/Terrain

Part# ASM-YCB — Yamaha G16-G22

Part# ASM-YCBDR — Yamaha Drive

DIAMOND CLAYS BASKET

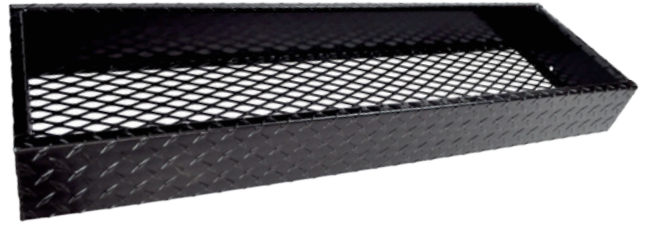

- 80 lb Carrying Capacity
- Works with Fold-Down Windshield
- Mounting Hardware Included
- Available in Textured or Satin

Part# ASM-PDCB — Club Car Precedent

Part# ASM-CDCB — Club Car DS

Part# ASM-EDCB — E-Z-GO TXT

Part# ASM-RXVDCB — E-Z-GO RXV

Part# ASM-WDCB — E-Z-GO Workhorse/Terrain

Part# ASM-YDCB — Yamaha G16-G22

Part# ASM-YDCBDR — Yamaha Drive

MESH CARGO BOX



- Dimensions: 30" x 43" x 6 1/2"
- Mounting Hardware Included
- Easy Installation
- Precedent Includes Top Supports

Part# ASM-PMCB — Club Car Precedent; Top Supports Included

Part# ASM-CMCB — Club Car DS; Top Supports Available for Old Style Carts

Part# ASM-EMCB — E-Z-GO TXT

Part# ASM-RXVMCB — E-Z-GO RXV

Part# ASM-YMCB — Yamaha G16-G22; Top Supports Available for G16-G19

Part# ASM-YMCBDR — Yamaha Drive

FISHING UTILITY BASKET



- Works on All Carts with Standard 2" Hitch
- High Quality Aluminum
- Easy Installation; Mounting Hardware Included
- 48-Quart Cooler
- Call for Custom Sizes
- Available in Textured or Satin

Part# ASM-FBWCR — With Red Cooler

Part# ASM-FBWCB — With Blue Cooler

Part# ASM-FBWOC — Without Cooler

ALL SPORTS COOLER



- 48-Quart Coleman® Cooler in Red or Blue
- Works with Fishing Utility Basket

Part# ASM-ACR — Red

Part# ASM-ACB — Blue

BUMPER BASKET



- Works on All Carts with standard 2" Hitch
- Easy Installation; Mounting Hardware Included
- Available in Textured or Satin

Part# ASM-BB — Universal

OVER DASH BASKET



- Works with Fold-Down and Sport Windshields
- Mounting Hardware Included
- Black Diamond w/ Mesh
- Available in Textured or Satin

Part# ASM-PODB — Club Car Precedent

Part# ASM-CODB — Club Car DS

Part# ASM-EODB — E-Z-GO TXT

Part# ASM-RXVODB — E-Z-GO RXV

Part# ASM-YODB — Yamaha G16-G22

Part# ASM-YODBDR — Yamaha Drive

UTILITY CARGO BOX



- Dimensions: 42" x 30" x 8 1/4"
- Precedent & Yamaha G16 Includes Top Supports
- Mill Finish available by request.
- Easy Fold-Down Tailgate w/ Rubber Latches for a "No-Creak" Ride!

BLACK

Part# ASM-PUCBB — Club Car Precedent; Top Supports Included

Part# ASM-CUCBB — Club Car DS; Top Supports Available for Older Carts

Part# ASM-EUCBB — E-Z-GO TXT

Part# ASM-EUCBNSB — E-Z-GO TXT 2014+

Part# ASM-RXVUCBB — E-Z-GO RXV

Part# ASM-YUCBB — Yamaha G16-G22; Top Supports Included

Part# ASM-YUCBBDR — Yamaha Drive

DIAMOND PLATE — Pictured

Part# ASM-PUCBD — Club Car Precedent; Top Supports Included

Part# ASM-CUCBD — Club Car DS; Top Supports Available for Older Carts

Part# ASM-EUCBD — E-Z-GO TXT

Part# ASM-EUCBNSD — E-Z-GO TXT 2014+

Part# ASM-RXVUCBD — E-Z-GO RXV

Part# ASM-YUCBD — Yamaha G16-G22; Top Supports Included

Part# ASM-YUCBDDR — Yamaha Drive



BRUSH GUARDS

BRUSH GUARD - STANDARD

CLUB CAR PRECEDENT



BLACK

Part# ASM-PBGB

STAINLESS — Pictured

Part# ASM-PBGS

CLUB CAR DS



BLACK

Part# ASM-CBGB

STAINLESS — Pictured

Part# ASM-CBGS

CLUB CAR DS - NEW STYLE



BLACK

Part# ASM-CBGNSB

STAINLESS — Pictured

Part# ASM-CBGNSS

E-Z-GO TXT



BLACK

Part# ASM-EBGB

STAINLESS — Pictured

Part# ASM-EBGS

E-Z-GO TXT - 2014 & UP



BLACK — Pictured

Part# ASM-EBGB14

STAINLESS

Part# ASM-EBGS14

E-Z-GO RXV



BLACK

Part# ASM-RXVBGB

STAINLESS — Pictured

Part# ASM-RXVBGS

YAMAHA G14/16/19



BLACK

Part# ASM-YBGB

STAINLESS — Pictured

Part# ASM-YBGS

YAMAHA G-22/GMAX



BLACK

Part# ASM-YBGGMB

STAINLESS — Pictured

Part# ASM-YBGGMS

YAMAHA DRIVE



BLACK

Part# ASM-YSRBGDRB

STAINLESS — Pictured

Part# ASM-YSRBGDRS

**ADD LIGHT MOUNTING TABS
TO ANY BRUSH GUARD!**



Call Today for Pricing

SINGLE BAR BRUSH GUARD



E-Z-GO TXT

Part# ASM-ESBGB — Black

Part# ASM-ESBGS — Stainless

E-Z-GO WORKHORSE

Part# ASM-WSBGB — Black

Part# ASM-WSBGS — Stainless

BRUSH GUARD W/ BUILT-IN HITCH

CLUB CAR PRECEDENT



- 2" Receiver
- Only Available in Textured or Satin Black

Part# ASM-PBGBWH

CLUB CAR DS



- 2" Receiver
- Only Available in Satin Black

Part# ASM-CBGBWH

WRAP AROUND BRUSH GUARD

CLUB CAR PRECEDENT



BLACK — Pictured

Part# ASM-PBGWAB

STAINLESS

Part# ASM-PBGWAS

CLUB CAR DS



BLACK — Pictured

Part# ASM-CBGWAB

STAINLESS

Part# ASM-CBWABS

E-Z-GO TXT



BLACK

Part# ASM-EBGWAB

STAINLESS — Pictured

Part# ASM-EGWAS

CLUB CAR PRECEDENT SPORTS RUNNER BRUSH GUARD



- Stainless Pictured

Part# ASM-PSRBGB — Black

Part# ASM-PSRBGS — Stainless

CLUB CAR DS SPORTS RUNNER BRUSH GUARD



- Stainless Pictured

Part# ASM-CSRGBB — Black

Part# ASM-CSRGBS — Stainless

E-Z-GO TXT SPORTS RUNNER BRUSH GUARD



- Light Mounting Tabs Included; Black Pictured

Part# ASM-ESRBGB — Black

Part# ASM-ESRBGS — Stainless

E-Z-GO RXV SPORTS RUNNER BRUSH GUARD



- Stainless Pictured

Part# ASM-RXVSRGBB — Black

Part# ASM-RXVSRBGS — Stainless

YAMAHA G14/16/19 SPORTS RUNNER BRUSH GUARD



- Stainless Pictured

Part# ASM-YSRBGB — Black

Part# ASM-YSRBGS — Stainless

YAMAHA G22/G-MAX SPORTS RUNNER BRUSH GUARD



- Black Pictured

Part# ASM-YSRBGGMB — Black

Part# ASM-YSRBGGMS — Stainless

MEGA SPORTS RUNNER BRUSH GUARD

CLUB CAR PRECEDENT



- OEM Light Compatible; Stainless Pictured

Part# ASM-PMSRBGB — Black

Part# ASM-PMSRBGS — Stainless

E-Z-GO TXT



- Stainless Pictured

Part# ASM-EMSRBGB — Black

Part# ASM-EMSRBGS — Stainless

MESH BRUSH GUARD

CLUB CAR DS



- Sits Below Headlights; Available in Black

Part# ASM-CMBGB

CLUB CAR DS - TALL



- Available only in Black

Part# ASM-CTMBGB

MODULAR BRUSH GUARD



- Available in Black w/ Silver or Black w/ Stainless

Part# ASM-CMODBGB — Silver

Part# ASM-CMODBGS — Stainless

MEGA BRUSH GUARD



- For Club Car DS

Part# ASM-CBGBM — Black

Part# ASM-CBGSM — Stainless

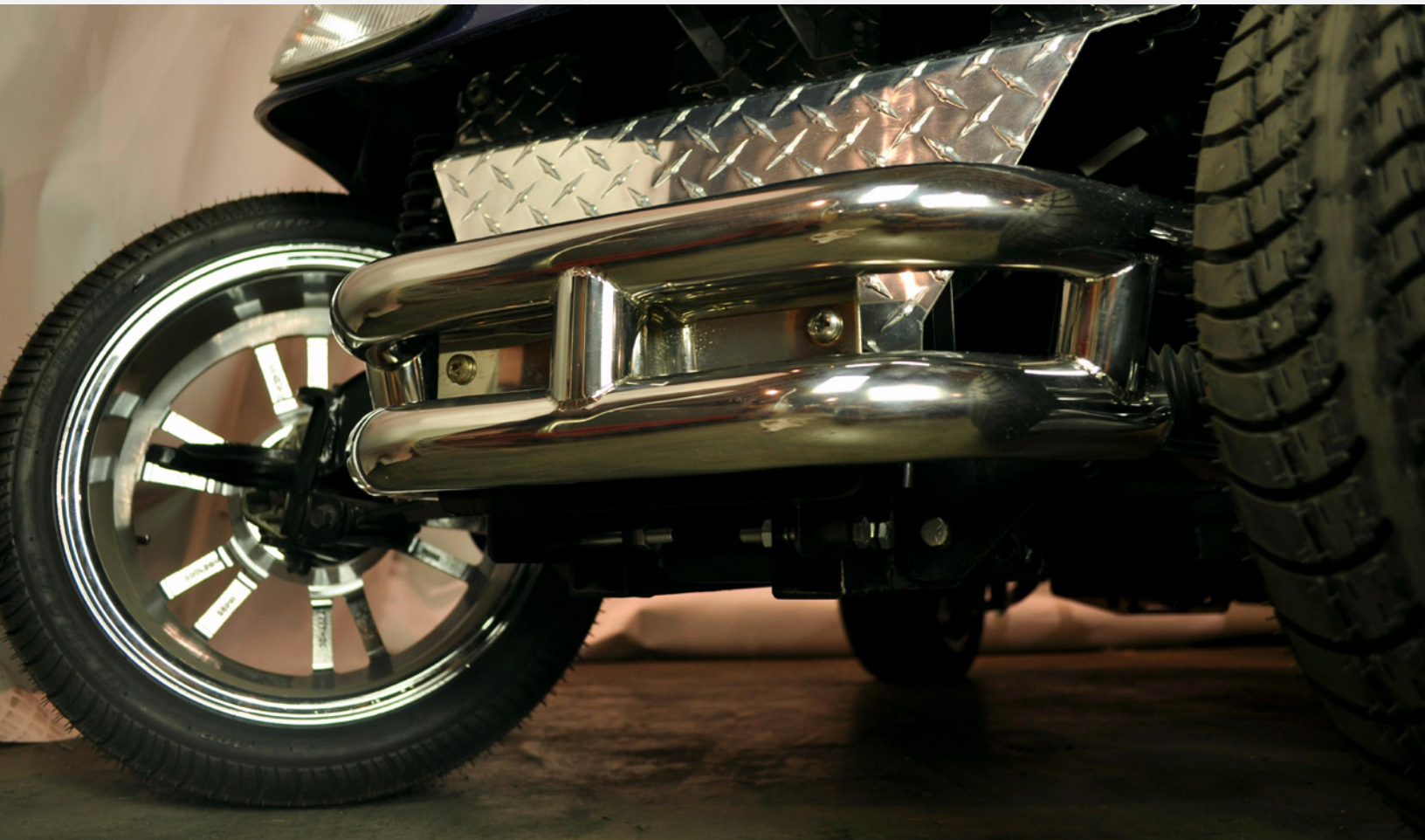

NERF BARS, STEPS & BUMPERS

NERF BARS & STEPS

STANDARD NERF BARS



- 1.25" Tubing (1.5" for Precedent)
- Mounting Brackets/Hardware Included

BLACK

Part# **ASM-PNBB** — Club Car Precedent

Part# **ASM-CNBB** — Club Car DS

Part# **ASM-ENBB** — E-Z-GO TXT

Part# **ASM-RXVNB** — E-Z-GO RXV

Part# **ASM-YNBB** — Yamaha G16-G22

Part# **ASM-YNBBDR** — Yamaha Drive

STAINLESS — Pictured

Part# **ASM-PNBS** — Club Car Precedent

Part# **ASM-CNBS** — Club Car DS

Part# **ASM-ENBS** — E-Z-GO TXT

Part# **ASM-RXVNBS** — E-Z-GO RXV

Part# **ASM-YNBS** — Yamaha G16-G22

Part# **ASM-YNBSDR** — Yamaha Drive

MEGA NERF BARS



- 1.75" Tubing
- Mounting Brackets/Hardware Included

BLACK

Part# **ASM-PMNBB** — Club Car Precedent

Part# **ASM-CMNBB** — Club Car DS

Part# **ASM-EMNBB** — E-Z-GO TXT

Part# **ASM-RXVMNBB** — E-Z-GO RXV

Part# **ASM-VMNBB** — Yamaha G16-G22

Part# **ASM-VMNBBDR** — Yamaha Drive

STAINLESS — Pictured

Part# **ASM-PMNBS** — Club Car Precedent

Part# **ASM-CMNBS** — Club Car DS

Part# **ASM-EMNBS** — E-Z-GO TXT

Part# **ASM-RXVMNBS** — E-Z-GO RXV

Part# **ASM-VMNBS** — Yamaha G16-G22

Part# **ASM-VMNBSDR** — Yamaha Drive

NERF BARS WITH DIAMOND STEP PLATE



- Available in Stainless or Black; Also Available in Custom Colors (pictured in Red) at an Additional Charge
- Diamond Step Plate available in Regular or Black Diamond Plate
- Mounting Hardware Included

Part# **ASM-PNBDSPB** — Club Car Precedent

Part# **ASM-CNBDSPB** — Club Car DS

Part# **ASM-ENBDSPB** — E-Z-GO TXT

Part# **ASM-YNBDSPB** — Yamaha G16-G22

Part# **ASM-YNBDSPDRB** — Yamaha Drive

ELITE NERF BARS

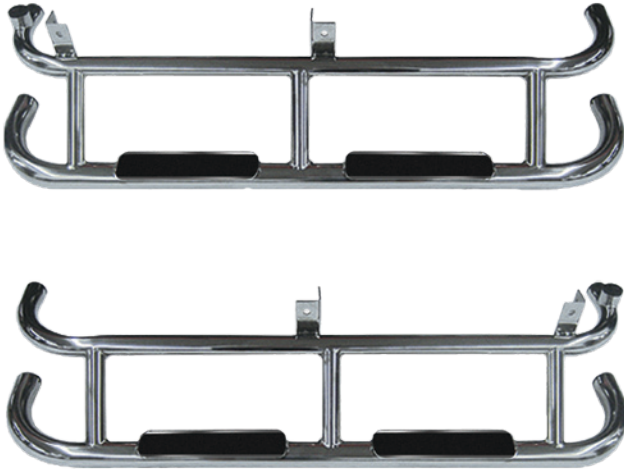

- 1.25" Tubing
- Mounting Brackets/Hardware Included
- Easy Installation

BLACK

Part# **ASM-PNBEB** — Club Car Precedent

Part# **ASM-CNBEB** — Club Car DS

Part# **ASM-ENBEB** — E-Z-GO TXT

STAINLESS — Pictured

Part# **ASM-PNBES** — Club Car Precedent

Part# **ASM-CN BES** — Club Car DS

Part# **ASM-ENBES** — E-Z-GO TXT

MEGA SPORTS STEPS



- 1.75" Tubing
- Mounting Hardware Included
- Easy Installation

BLACK

Part# **ASM-PMSSB** — Club Car Precedent

Part# **ASM-CMSSB** — Club Car DS

Part# **ASM-EMSSB** — E-Z-GO TXT

Part# **ASM-YMSSB** — Yamaha G16-G22

Part# **ASM-YMSSDRB** — Yamaha Drive

STAINLESS — Pictured

Part# **ASM-PMSSS** — Club Car Precedent

Part# **ASM-CMSSS** — Club Car DS

Part# **ASM-EMSSS** — E-Z-GO TXT

Part# **ASM-YMSSS** — Yamaha G16-G22

Part# **ASM-YMSSDRS** — Yamaha Drive

MEGA SPORTS STEPS w/ STEP PLATES - BLACK



Part# **ASM-PMSSBWP** — Club Car Precedent

Part# **ASM-CMSSBWP** — Club Car DS

Part# **ASM-EMSSBWP** — E-Z-GO TXT

Part# **ASM-YMSSBWP** — Yamaha G16-G22

Part# **ASM-YMSSDRBWP** — Yamaha Drive

MEGA SPORTS STEPS w/ STEP PLATES - STAINLESS



Part# **ASM-PMSSSWP** — Club Car Precedent

Part# **ASM-CMSSSWP** — Club Car DS

Part# **ASM-EMSSSWP** — E-Z-GO TXT

Part# **ASM-YMSSSWP** — Yamaha G16-G22

Part# **ASM-YMSSDRSWP** — Yamaha Drive

STANDARD SPORTS STEPS



- 1.25" Tubing (1.5" for Precedent)
- Mounting Hardware Included
- Easy Installation
- Polished Stailness Steel

BLACK — Textured or Satin Finish

Part# **ASM-PSSB** — Club Car Precedent; Black

Part# **ASM-CSSB** — Club Car DS; Black

Part# **ASM-ESSB** — E-Z-GO TXT; Black

Part# **ASM-YSSB** — Yamaha G16-G22; Black

Part# **ASM-YSSBDR** — Yamaha Drive; Black

STAINLESS — Pictured

Part# **ASM-PSSS** — Club Car Precedent; Stainless

Part# **ASM-CSSS** — Club Car DS; Stainless

Part# **ASM-ESSS** — E-Z-GO TXT; Stainless

Part# **ASM-YSSS** — Yamaha G16-G22; Stainless

Part# **ASM-YSSSDR** — Yamaha Drive; Stainless

STANDARD SPORTS STEPS w/ STEP PLATES



- 1.25" Tubing (1.5" for Precedent)
- Mounting Hardware Included
- Easy Installation
- Polished Stailness Steel

BLACK — Textured or Satin Finish

Part# **ASM-PSSBWP** — Club Car Precedent

Part# **ASM-CSSBWP** — Club Car DS

Part# **ASM-ESSBWP** — E-Z-GO TXT

Part# **ASM-YSSBWP** — Yamaha G16-G22

Part# **ASM-YSSBWPDR** — Yamaha Drive

STAINLESS — Pictured

Part# **ASM-PSSSWP** — Club Car Precedent

Part# **ASM-CSSSWP** — Club Car DS

Part# **ASM-ESSSWP** — E-Z-GO TXT

Part# **ASM-YSSSWP** — Yamaha G16-G22

Part# **ASM-YSSSWPDR** — Yamaha Drive

BUMPERS

MEGA FRONT BUMPER



- Stainless Precedent Bumper Pictured
- Works with OEM Light

CLUB CAR PRECEDENT

Part# ASM-PMFBB — Black

Part# ASM-PMFBS — Stainless

CLUB CAR DS

Part# ASM-CMFBB — Black

Part# ASM-CMFBS — Stainless

E-Z-GO RXV

Part# ASM-RXVMFBB — Black

Part# ASM-RXVMFBS — Stainless

CLUB CAR DS SINGLE REAR BUMPER



Part# ASM-CMSRBB — Black

Part# ASM-CMSRBS — Stainless

CLUB CAR DS DOUBLE REAR BUMPER



Part# ASM-CMDRBB — Black

Part# ASM-CMDRBS — Stainless

CLUB CAR DS FRONT BUMPER



- For Club Car DS Models 1984 - Present
- Available in Stainless Steel or Black (Textured or Satin Finish)

Part# ASM-CFBB — Black

Part# ASM-CFBS — Stainless

YAMAHA FRONT BUMPER



G14/G16/G19

Part# ASM-YFBB — Black

Part# ASM-YFBS — Stainless

G22/G-MAX

Part# ASM-YFBGMB — Black

Part# ASM-YFBGMS — Stainless

CLUB CAR DS MESH REAR BUMPER



Part# ASM-CMRB — Black

CLUB CAR DS MODULAR REAR BUMPER



Part# ASM-CRBMOD — Black

Part# ASM-CRBMODS — Silver

E-Z-GO TXT MEGA REAR BUMPER



Part# ASM-EMRBB — Black

Part# ASM-EMRBS — Stainless

E-Z-GO TXT REAR BUMPER w/ HITCH

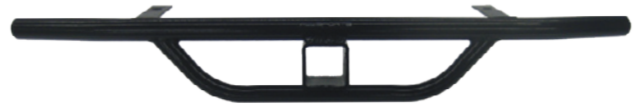

Part# ASM-ERBWH — Black

REAR BUMPER - STANDARD

CLUB CAR PRECEDENT



Part# ASM-PRBB — Black

Part# ASM-PRBS — Stainless

CLUB CAR DS



Part# ASM-CRBB — Black

Part# ASM-CRBS — Stainless

E-Z-GO TXT



- Fits E-Z-GO TXT Models 1994.5 - Present
- Available in Stainless Steel & Powder Coat Black

Part# ASM-ERBB — Black

Part# ASM-ERBS — Stainless

YAMAHA



G14/G16/G19

Part# ASM-YRBB — Black

Part# ASM-YRBS — Stainless

DRIVE

Part# ASM-YRBDRB — Black

Part# ASM-YRBDRS — Stainless



LIGHT KITS & MIRRORS

NAVIGATOR 6" ROUND LIGHTS



- Mounts On Brush Guard or Light Bar
- Rugged Plastic Housing; 5 1/2" x 6" x 2 3/4"
- Kit Includes: 2 Halogen Lamps, Wiring Harness, Relay Fuse, Switch w/ Housing, Mounting Brackets w/ Screws & Installation Instructions

Part# ASM-SRLS01

UNIVERSAL HEAD LIGHT



- Fluted Lens for Even Light Distribution
- 6 1/8" x 2 5/8" x 2 1/2"
- Kit Includes: 55 Watt H3 Halogen Bulb, Wiring Harness, Mounting Hardware & Switch w/ Housing

Part# ASM-SRLS02

ASK US ABOUT LED LIGHT KITS

FOR CLUB CAR PRECEDENT & DS,
E-Z-GO TXT & RXV, AND YAMAHA DRIVE!



SIDE MIRRORS



- Fits Most Models
- Mirrors Bolt to Top Supports
- Mounting Hardware Included

Part# ASM-USVM

5 PANEL REAR VIEW MIRROR



- Fits Most Models
- Installs Easily between Cart's Top Supports
- Great for Street Legal Carts

Part# ASM-5PRVMPRECEDENT — Club Car Precedent

Part# ASM-5PRVMCLUBCAR — Club Car DS

Part# ASM-5PRVMTXT — E-Z-GO TXT

Part# ASM-5PRVMY469 — Yamaha G14/G16/G19

Part# ASM-5PRVMYDRGM — Yamaha Drive/G22



HITCHES

CLUB CAR PRECEDENT HITCH ASSEMBLY



- 2" Light Duty Hitch Application
- Purchase Pieces Separately (Optional)

Part# ASM-PHA — Full Assembly (A & B)

Part# ASM-PH — Hitch Only (A)

Part# ASM-RH — Receiving Hitch (B)

CLUB CAR PRECEDENT HEAVY DUTY FRONT HITCH



- 2" Light Duty Hitch Application
- Purchase Pieces Separately (Optional)

Part# ASM-PHHA — Full Assembly (A & B)

Part# ASM-PHH — Hitch Only (A)

Part# ASM-RH — Receiving Hitch (B)

CLUB CAR DS HITCH ASSEMBLY



- 2" Hitch Assembly Bolts to Rear of Cart's Frame
- Purchase Pieces Separately (Optional)

Part# ASM-CHA — Full Assembly (A & B)

Part# ASM-CH — Hitch Only (A)

Part# ASM-RH — Receiving Hitch (B)

CLUB CAR DS FRONT HITCH ASSEMBLY

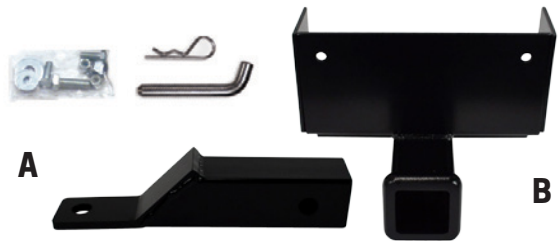

- 2" Light Duty Hitch Application
- Purchase Pieces Separately (Optional)

Part# ASM-CFHA — Full Assembly (A & B)

Part# ASM-CFH — Hitch Only (A)

Part# ASM-RH — Receiving Hitch (B)

CLUB CAR DS LIGHT DUTY HITCH



- Made for Low Capacity Towing Only
- Mounting Hardware Included
- Easy to Install

Part# ASM-CLDH

E-Z-GO TXT FRONT HITCH ASSEMBLY



- Compatible w/ All Sports Lift Kits Only (Excluding Long Travel)

Part# ASM-EFHA — Full Assembly; 2001 - Present

Part# ASM-EFH94A — Full Assembly; 1994 - 2000

E-Z-GO HITCH ASSEMBLY

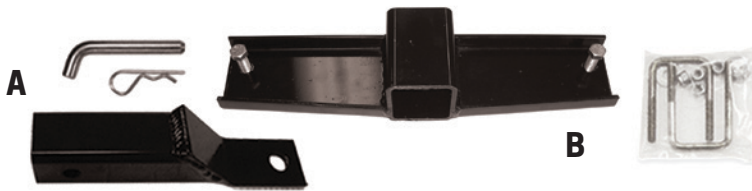

- 2" Hitch Assembly
- Simple Installation
- Purchase Pieces Separately (Optional)

Part# ASM-EHA — Full Assembly; E-Z-GO TXT (A & B)

Part# ASM-EH — TXT Hitch Only (A)

Part# ASM-RH — Receiving Hitch (B)

E-Z-GO RXV HITCH ASSEMBLY



- Bolts to Rear of Cart's Frame
- Purchase Pieces Separately (Optional)
- Hitch Ball Not Included

Part# ASM-RXVHA — Full Assembly (A & B)

Part# ASM-RXVH — Hitch Only (A)

Part# ASM-RH — Receiving Hitch (B)

HITCH EXTENSION



- Great Accessory for a Golf Cart with a Seat Kit & Hitch
- Hitch Extension Allows Use of Hitch Without Interfering with Seat Kit

Part# ASM-HE

WINCH MOUNT HITCH



- Fits Any 2" Hitch - Mount a Winch to This Receiver for Any Model Cart!
- Pin Included

Part# ASM-WMH — 2001 - Present

UNIVERSAL HITCH ASSEMBLY

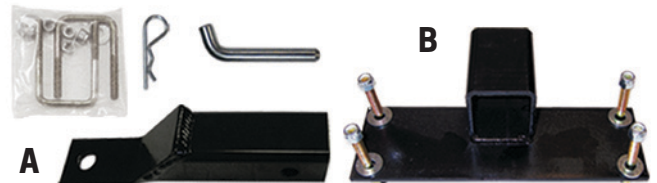

- 2" Hitch Assembly
- Universal Application for Golf Carts
- Includes Mounting Hardware
- Purchase Pieces Separately (Optional)

Part# ASM-UHA — Full Assembly (A & B)

Part# ASM-UH — Hitch Only (A)

Part# ASM-URH — Receiving Hitch (B)



TIRES & WHEELS

TIRES

STI SLASHER



23 x 10.5 - 12

22 x 10 - 10

22 x 11 - 12

GBC AFTERBURN



25 x 10 - 12 — 4 Ply

GBC DIRT DEVIL



25 x 10 - 12 — 6 Ply

GBC GREENSAVER



- Low Profile Options

23 x 10.5 - 12 — 4 Ply

20 x 10 - 10 — Plus; 4 Ply

GBC KANATI MONGREL



30 x 10 - 14 — 8 Ply

28 x 10 - 14 — 8 Ply

26 x 10 - 12 — 8 Ply

PROFIT BACKLASH



- Low Profile Options Available

23 x 10 - 14

215/35 - 14

CARLISLE MUD WOLF



27 x 12 - 12 — 6 Ply

26 x 12 - 12 — 6 Ply

25 x 11 - 12 — 6 Ply

MAXXIS BIG HORN



- Excellent traction in mud and rocky terrain
- Great handling on hard terrain

27 x 12 - 12 — 6 Ply

MAXXIS BIG HORN 2.0



26 x 9 - 14 — 6 Ply

25 x 10 - 12 — 6 Ply

23 x 10 - 12 — 6 Ply

MAXXIS VIPR



- For intermediate to loose terrain

26 x 11 - 12 — 6 Ply

25 x 10 - 12 — 6 Ply

MAXXIS CORONADO



28 x 10 - 14 — 6 Ply

26 x 11 - 12 — 6 Ply

25 x 10 - 12 — 6 Ply

MAXXIS MUD BUG



- Superior traction in mud

26 x 10 - 12 — 6 Ply

25 x 10 - 12 — 6 Ply

ITP ULTRA GT



- DOT Approved

27 x 12 - 12

27 x 12 - 12

ITP ALL TRAIL XLT



23 x 10.5 - 12 — 4 Ply

22 x 10 - 10 — 4 Ply

20 x 10 - 10 — 4 Ply

ITP MUD LITE



- For high-performance trail riding

6 Ply

DURO POWER TRAIL



- 2-Ply
- Designed for trail use and motocross racing

18 x 9.5 - 8

DURO SCORCHER



- 4-Ply
- Large contact patch for increased grip during cornering

28 x 10 - 10 — 4 Ply

DURO DESERT



- 4-Ply

23 x 10 - 14

23 x 10.5 - 12

ITP ULTRACROSS



- DOT Approved
- 6-ply radial

23 x 12 - 12

VEE MERCENARY



28 x 10 - 14 — White

28 x 10 - 14 — Blue

28 x 10 - 14 — Red

WHEELS

BLACK STEEL



- Available in Black

Set of 4

ITP SS6B



- Available in Machined/Black

Set of 4

ITP SS6M



- Available in Machined

Set of 4

ITP SS112



- Available in 10" (Left), 12" (Center), or 14" (Right); Set of 4

10" — Chrome or Machined

12" — Chrome or Machined

14" — Chrome or Machined

ITP SS212



- Available in Chrome (Pictured), Machined, or Black

- Set of 4

12"

ITP SS312



- Available in 12" or 14" in Machined (Pictured) or Chrome

12" — Chrome or Machined

14" — Offset; Machined Only

ITP SS216



- Available in Machined or Matte Black
- 2+5 Offset

12"

ITP SS316



- Available in Machined
- Reinforced Rock Armor inner wheel lip design
- Set of 4

12"

ITP TYPE 6



- Available in Machined (Pictured) or Matte Black
- Set of 4

10"

ITP TYPE 7: STORM TROOPER



- Available in 10", 12", or 14", in Machined, Matte Black, Red, Blue/Black, Blue/White, or White
- Set of 4

10" — Machined or Matte Black Only

12" — Available in 6 Colors

14" — Available in 6 Colors

ITP TYPE 8



- Available in Machined (Pictured) or Matte Black
- Set of 4

12"

ITP TYPE 9: TEMPEST



- Available in 10", 12", or 14", in Machined, Matte Black, Red, Blue/Black, Blue/White, or White
- Set of 4

10" — Machined or Matte Black Only

12" — Available in 6 Colors

14" — Available in 6 Colors

ITP TYPE 10: CHAOS



- Available in Machined, Matte Black (Pictured), or Red
- Set of 4

14"

ITP TYPE 11: RAMPAGE



- Available in Machined (Left), Matte Black, or Red (Right)
- Set of 4

12" — Available in Machined Only

14" — Available in 3 Colors

ITP TYPE 12: VAMPIRE



- Available in Machined, Matte Black, or Red; Set of 4

10" — Machined Only (Left)

12" — Machined (Center) or Red

14" — Available in 3 Colors (Matte Black Shown Right)

ITP SS108 12



MATTE BLACK — Pictured

12" — Set of 4

MACHINED

12" — Set of 4

ITP HURRICANE 14



- Available in Matte Black
- Set of 4

12"

14"

STI HD6 RADIANT 10



- Available in Red, Blue, or Orange (Pictured)
- Set of 4

10"

STI HD7 14



- Available in Blue, Orange, Red, or Smoke
- Set of 4

14"

TIRE & WHEEL ACCESSORIES

1" WHEEL SPACER



- Sold Individually

Part# ASM-WS1

2" WHEEL SPACER



- Sold Individually

Part# ASM-WS2

8" SS WHEEL COVER



Part# ASM-WC8

TIRE & WHEEL KITS

8" BLACK STEEL ON 18" POWER TRAIL



- 18" Duro Power Trail Tires

10" BLACK STEEL ON ATV TIRE



- 20" or 22" ATV Tires (Pictured)

10" OCTO ON 22" BACKLASH



- 22" Backlash Tires

10" ITP SS6B ON 23" GREENSAVER



- Available in Machined
- 22" Slasher and 23" Greensaver Tires (Pictured)

10" STI HD3 ON 18" DURO SCORCHER



- Silver HD3 Wheel
- 18"x10"-10" Duro Scorcher Tires

10" STI HD3 ON 22" SLASHER



- Available in Black or Machined (Pictured)
- 22" Slasher Tires
- Also available in 20"

**12" ROC TURBINE ON 23"
DURO DESERT - SILVER**



- 12" Roc Turbine Wheels
- Silver Shown
- 23"x10"-12" Duro Desert

**12" ROC TURBINE ON 23"
DURO DESERT - MACHINED**



- 12" Roc Turbine Wheels
- Machined/Black Shown
- 23"x10"-12" Duro Desert

**12" ITP SS212 ON
23" STI ATX**



- Available in Black or Machined (Pictured)
- 23" STI ATX Trail Tires

**12" DIAMOND ON
23" BACKLASH**



- Available in Machined
- 12" Wheels
- 23" Backlash Tires

**12" ITP SS316 ON
23" ITP ULTRACROSS**



- Available in Machined
- 12" Wheels
- 23"x10"-12" Ultracross Tires

**12" REVOLVER ON
23" BACKLASH**



- Available in Machined
- 23" Backlash Tires

**12" LOCKER ON
23" BACKLASH**



- Available in Machined
- 23" Backlash Tires

**12" BUCKSHOT ON
23" BACKLASH**



- Available in Machined
- 12" Wheels
- 23" Backlash Tires

**14", 12", or 10" SS112
ON 23" STI ATX TRAIL**



- Available in Machined
- 23" ATX Trail
- 14" Wheel Pictured

14" OPTIMUS ON BACKLASH



- Available in Machined/Black
- 23" or 215/35-15 Backlash Tires

14" BLITZ ON 23" PRO FIT PIONEER



- Black or Machined (Pictured)
- 23" Pro Fit Tires

14" MEGASTAR ON BACKLASH



- Available in Machined, Matte Black, Chrome, or Black Chrome (Pictured)
- 215/35-15 (Shown) or 23x10-14

14" HD7 ON 23" DURO DESERT



- Blue/Black (Pictured), Red/Black, Orange/Black or Smoke Grey/Black
- 23" Duro Tires

12" ITP SS212 ON 23" ITP ULTRACROSS



- Black (Pictured) or Machined
- 23" Ultracross Tires

14" MAMBA ON BACKLASH



- Black & Machined
- 23" or 215/35-15 Backlash Tires
- 23" Backlash Tires Pictured

14" HURRICANE ON 23" DURO DESERT - MATTE BLACK



- Works on a variety of tires
- 14" Matte Black ITP Hurricane Wheel
- 23" Duro Desert Pictured Tire

14" HURRICANE ON 23" DURO DESERT - MACHINED



- Works on a variety of tires
- 14" Machined ITP Hurricane Wheel
- 23" Duro Desert Tire

EVEN MORE COMBOS



Give us a call for even more options! We're rolling out new combos so fast it will make your head spin!



MORE ACCESSORIES

WINDSHIELDS

FLEX-FOLD WINDSHEILD



- No Metal Hinges — Rust Resistant
- High Impact Resistant
- Available in Clear and Tinted
- High Clarity Acrylic for Better Visibility
- Designed for Use with OEM Front Struts Only

CLEAR

Part# ASM-PWSCLEAR — Club Car Precedent

Part# ASM-CWSCLEAR99 — Club Car DS; 1984 - 1999

Part# ASM-CWSCLEAR2000+ — Club Car DS; 2000 - Present

Part# ASM-EWSCLEAR — E-Z-GO TXT; 2013 & Older

Part# ASM-EWSCLEAR2014+ — E-Z-GO TXT; 2014 - Present

Part# ASM-YWSCLEAR — Yamaha G14/16/19

Part# ASM-YWS22CLEAR — Yamaha G22/G-Max

Part# ASM-YWSDRCLEAR — Yamaha Drive

TINTED

Part# ASM-PWSTINTED — Club Car Precedent

Part# ASM-CWSTINTED99 — Club Car DS; 1984 - 1999

Part# ASM-CWSTINTED2000+ — Club Car DS; 2000 - Present

Part# ASM-EWSTINTED — E-Z-GO TXT; 2013 & Older

Part# ASM-EWSTINTED2014+ — E-Z-GO TXT; 2014 - Present

Part# ASM-YWSTINTED — Yamaha G14/16/19

Part# ASM-YWS22TINTED — Yamaha G22/G-Max

Part# ASM-YWSDRTINTED — Yamaha Drive

SPORT WINDSHIELD



- High Quality Tinted Lexan Glass
- Stainless Hardware Included
- Only Half Height
- Carbon Steel or Stainless Steel
- Replacement glass available
- Only Available in Tinted

BLACK

Part# **ASM-PSWB** — Club Car Precedent

Part# **ASM-CSWB** — Club Car DS

Part# **ASM-ESWB** — E-Z-GO TXT or Workhorse

Part# **ASM-RXVSWB** — E-Z-GO RXV

Part# **ASM-YSWB** — Yamaha G14/16/19

Part# **ASM-YSWBDR** — Yamaha Drive

STAINLESS

Part# **ASM-PSWS** — Club Car Precedent

Part# **ASM-CSWS** — Club Car DS

Part# **ASM-ESWS** — E-Z-GO TXT or Workhorse

Part# **ASM-RXVSWWS** — E-Z-GO RXV

Part# **ASM-YSWS** — Yamaha G14/16/19/G22

Part# **ASM-YSWSDR** — Yamaha Drive

FENDER FLARES

FENDER FLARES



- Each Set Includes Four 3" Wide Injection-Molded Plastic Fender Flares w/ Textured Finish & Mounting Hardware
- Not compatible with wrap-around brush guards

Part# **ASM-PFF** — Club Car Precedent

Part# **ASM-CFF** — Club Car DS

Part# **ASM-EFF** — E-Z-GO TXT

Part# **ASM-RXVFF** — E-Z-GO RXV

Part# **ASM-YFF** — Yamaha

Part# **ASM-YFFDR** — Yamaha Drive

DASHES

CLUB CAR PRECEDENT DASH



- For Models 1982 - Present
- Available in Black, Carbon Fiber, or Regal (Pictured)

Part# ASM-PDC01 — Black

Part# ASM-PDC02 — Carbon Fiber

Part# ASM-PDC03 — Regal

CLUB CAR DS DASH



- For Models 1982 - Present
- Available in Black (Pictured), Carbon Fiber, or Regal

Part# ASM-PDC01 — Black

Part# ASM-PDC02 — Carbon Fiber

Part# ASM-PDC03 — Regal

E-Z-GO TXT DASH



- For Models 1982 - Present
- Available in Black, Carbon Fiber (Pictured), or Regal

Part# ASM-PDC01 — Black

Part# ASM-PDC02 — Carbon Fiber

Part# ASM-PDC03 — Regal

SEAT BELTS

RETRACTABLE SEAT BELT



- Can be mounted on Front or Rear Seats
- Hardware Included

Part# ASM-RSB

RETRACTABLE SEAT BELT KIT

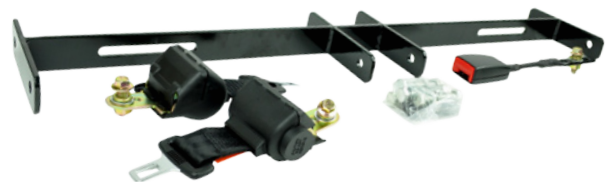

- Kit Includes: Two Retractable Seat Belts, Mounting Hardware, & Universal Seat Kit Bracket

Part# ASM-RSBK — 2-Passenger

Part# ASM-RSBK4P — 4-Passenger

STEERING WHEELS & STEERING ACCESSORIES

GRANT® SUEDE SERIES



- Made of 1.25" Diameter Tubing
- Available in Black with Red, Orange, Yellow, or Blue accents

Part# ASM-GH90S — With Red Accents

Part# ASM-GH90B — With Blue Accents

Part# ASM-GH90S — With Yellow Accents

Part# ASM-GH90B — With Orange Accents

GRANT® FORMULA 4



- Accepts 3 or 5 Hole Adapter

BLACK — Left

Part# ASM-180-14

BRUSHED ALUMINUM — Right

Part# ASM-181-14

GRANT® FORMULA 1



- Accepts 3 or 5 Hole Adapter

BLACK — Left

Part# ASM-190-14

BRUSHED ALUMINUM — Right

Part# ASM-191-14

GRANT® SURE GRIP



- Accepts 3 or 5 Hole Adapter
- Maximum control in rain, snow, cold, heat

BLACK

Part# ASM-8511

GRANT® D-SERIES



Part# ASM-GH90B — With Red Suede Accent

Part# ASM-GH90S — With Orange Suede Accent

Part# ASM-GH90B — With Yellow Suede Accent

Part# ASM-GH90S — With Blue Suede Accent

Part# ASM-GH90B — With Grey Suede Accent

Part# ASM-GH90S — With Black Suede Accent

GRANT® 701



- 3-Spoke Chrome
- Accepts 3 & 5 Hole Steering Adapters

Part# ASM-701

GRANT® 415



- 4-Spoke Brushed Aluminum
- Only Accepts 3 Hole Steering Adapters

Part# ASM-415

GRANT® 870



- 3-Spoke Black
- Only Accepts 3 Hole Steering Adapters

Part# ASM-870

STEERING ADAPTERS



- Made of High Quality Billet Aluminum
- Looks great with a steering column cover

3 HOLE

Part# ASM-CSA — Club Car DS

Part# ASM-ESA — E-Z-GO TXT

Part# ASM-MSA — E-Z-GO Marathon

Part# ASM-YSA — Yamaha

3 HOLE MEGA

Part# ASM-PMSA3 — Club Car Precedent

Part# ASM-CMHSA3 — Club Car DS

Part# ASM-EMHSA3 — E-Z-GO TXT

Part# ASM-YMHSA3 — Yamaha

5 HOLE MEGA

Part# ASM-PMSA5 — Club Car Precedent

Part# ASM-CMHSA5 — Club Car DS

Part# ASM-EMHSA5 — E-Z-GO TXT

Part# ASM-RXVMSA5 — E-Z-GO RXV

Part# ASM-YMHSA5 — Yamaha

GRANT® 990



- 3-Spoke Chrome
- Accepts 3 & 5 Hole Steering Adapters

Part# ASM-990

STRETCH® BLACK TYPHOON



- 1/2 Wrap Billet
- Only Accepts 5 Hole Steering Adapters

Part# ASM-SW001

STEERING COLUMN COVER



- High Quality Stainless

CLUB CAR PRECEDENT

Part# ASM-PCC

CLUB CAR DS

Part# ASM-CCC01 — 2001 - Present

Part# ASM-CCC — 1982 - 2001

E-Z-GO TXT

Part# ASM-ECC — 1994.5 - 2001.5

Part# ASM-ECC01 — 2001 - Present

E-Z-GO RXV

Part# ASM-RXVCC — 2008 - Present

E-Z-GO MARATHON

Part# ASM-MCC — Pre-1994

YAMAHA

Part# ASM-YCC1 — G1

Part# ASM-YCC29 — G2 - G9

Part# ASM-YCC — G14/16/19

Part# ASM-YCCDR — Drive

ENCLOSURES & COVERS

UNIVERSAL FIT COVER



- 2-Passenger & 4-Passenger Covers
- Storage Bag Included
- Maximum Water Resistance
- 1 Year Limited Warranty

Part# ASM-72003SC — 2-Passenger

Part# ASM-74442 — 4-Passenger

ENCLOSURES



- Heavy Duty Protection against Bad Weather
- Installs in Minutes without Tools
- 3 Year Warranty

Part# ASM-40-060 — Club Car Precedent

Part# ASM-72042 — Club Car DS

Part# ASM-40-014 — E-Z-GO TXT

Part# ASM-40-056 — Yamaha Drive

OTHER ACCESSORIES

CLUB CAR DS SIDE INSERTS



- Replaces OEM Rubber Insert
- Available with or without Holes

Part# ASM-CSBIB — Black

Part# ASM-CSBID — Diamond

Part# ASM-CSBIS — Stainless (Shown)

ADD-A-LEAF SET



- Fits Club Car DS, Precedent, and E-Z-GO

Part# ASM-AL

CLUB CAR DS FRONT COVER

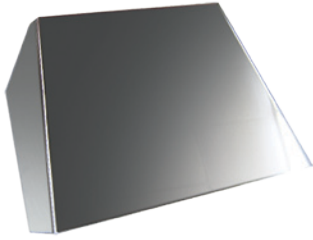

- 20 Gauge Aluminum or High Quality Stainless Steel; All Hardware Included

Part# ASM-CFCB — Black

Part# ASM-CFCD — Diamond

Part# ASM-CFCS — Stainless Steel

CLUB CAR DS MUD GUARDS



- For Models 1982 - Present

Part# ASM-CMGB — Black

Part# ASM-CMGD — Diamond

Part# ASM-CMGS — Stainless

BILLET EASY SPORT SHIFTER



- Made of High Quality Billet Aluminum
- Works for Both Gas & Electric
- No IQ Systems

Part# ASM-CBSS — Club Car DS

Part# ASM-EBSS — E-Z-GO

E-Z-GO SHOCK COVER

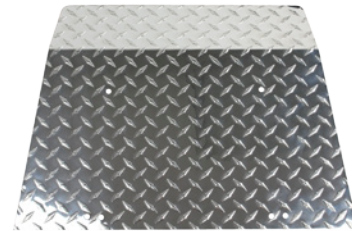

- Replaces Black Plastic Cover
- Not compatible with Long Travel

Part# ASM-ESCB — Black

Part# ASM-ESCD — Diamond

Part# ASM-ESCS — Stainless

90° UNIVERSAL GRAB HANDLES



- Set of 2

BLACK

Part# ASM-GH90B

STAINLESS

Part# ASM-GH90S

E-Z-GO TXT SIDE GRAB HANDLES



BLACK

Part# ASM-SGHB

STAINLESS

Part# ASM-SGHS

E-Z-GO PEDAL SETS

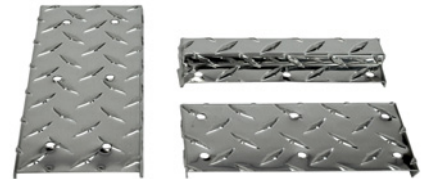

- Aluminum Diamond Plate
- Does Not Come With Forward/Reverse Handle

TXT 94' - PRESENT

Part# ASM-EPSD

MARATHON

Part# ASM-MPSD

CLUB CAR PRECEDENT SEAT BACK SUPPORTS



- Made of 1.25" Diameter Tubing

Part# **ASM-PSBB** — Black

Part# **ASM-PSBS** — Stainless

E-Z-GO TXT SEAT BACK SUPPORTS



- Available with Optional Roof Support
- Made of 1.25" Diameter Tubing
- Available in Black or Stainless

NO ROOF SUPPORT BRACKET

Part# **ASM-ESBSB** — Black

Part# **ASM-ESBSS** — Stainless

WITH ROOF SUPPORT BRACKET

Part# **ASM-ESBSRBB** — Black

Part# **ASM-ESBSRB** — Stainless

CLUB CAR DS SEAT BACK SUPPORTS



- 1.25" Tubing
- Mounting Brackets/Hardware Included
- Easy Installation
- Club Car DS Stainless Pictured

Part# **ASM-CSBSB012P** — Club Car DS 2001 - Present; 2 Passenger; Black

Part# **ASM-CSBSB014P** — Club Car DS 2001 - Present; 4 Passenger; Black

Part# **ASM-CSBSB2P** — Club Car DS 1984 - 2000; 2 Passenger; Black

Part# **ASM-CSBSB4P** — Club Car DS 1984 - 2000; 4 Passenger; Black

Part# **ASM-CSBS012P** — Club Car DS 2001 - Present; 2 Passenger; Stainless

Part# **ASM-CSBS014P** — Club Car DS 2001 - Present; 4 Passenger; Stainless

Part# **ASM-CSBS2P** — Club Car DS 1984 - 2000; 2 Passenger; Stainless

Part# **ASM-CSBS4P** — Club Car DS 1984 - 2000; 4 Passenger; Stainless

ORNAMENTAL ROLL BAR



- 1.25" (Standard) or 1.75" (Mega) Stainless Steel Tubing
- Mounting Hardware Included
- Easy Installation
- Not Compatible w/ Rear Seats
- Standard Roll Bar Pictured

STANDARD, BLACK — 1.25" Tubing

Part# **ASM-CORBB** — Club Car DS

Part# **ASM-EORBB** — E-Z-GO TXT

Part# **ASM-RXVORBB** — E-Z-GO RXV

Part# **ASM-YORBB** — Yamaha G14/16/19

Part# **ASM-YORBBDR** — Yamaha Drive

STANDARD, STAINLESS — 1.25" Tubing

Part# **ASM-CORBS** — Club Car DS; Stainless

Part# **ASM-EORBS** — E-Z-GO TXT; Stainless

Part# **ASM-RXVORBS** — E-Z-GO RXV; Stainless

Part# **ASM-YORBS** — Yamaha G14/16/19; Stainless

Part# **ASM-YORBSDR** — Yamaha Drive; Stainless

MEGA, BLACK — 1.75" Tubing

Part# **ASM-CMORBB** — Club Car DS; Black

Part# **ASM-EMORBB** — E-Z-GO TXT; Black

Part# **ASM-RXVMORBB** — E-Z-GO RXV; Black

Part# **ASM-YMORBB** — Yamaha G14/16/19; Black

Part# **ASM-YMORBBDR** — Yamaha Drive; Black

MEGA, STAINLESS — 1.75" Tubing

Part# **ASM-CMORBS** — Club Car DS; Stainless

Part# **ASM-EMORBS** — E-Z-GO TXT; Stainless

Part# **ASM-RXVMORBS** — E-Z-GO RXV; Stainless

Part# **ASM-YMORBS** — Yamaha G14/16/19; Stainless

Part# **ASM-YMORBSDR** — Yamaha Drive; Stainless

FLOOR MOUNT 2-GUN HOLDER



- Fits Most Models; Requires 6"x6" Floor Space
- Fits Two Rifles or Shotguns
- 120° of Movement
- 4-Gun Mount Also Available

Part# ASM-FMTGH

ACCESS PANEL

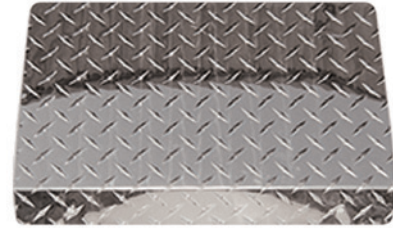

- Replaces OEM Access Panel
- 20 Gauge Aluminum or High Quality Stainless Steel
- Diamond Plate Yamaha Access Panel Pictured

BLACK

Part# ASM-PAPB — Club Car Precedent

Part# ASM-CAPB — Club Car DS

Part# ASM-EAPB — E-Z-GO

Part# ASM-YAPB — Yamaha G14-G19, G22

DIAMOND

Part# ASM-PAPD — Club Car Precedent

Part# ASM-CAPD — Club Car DS

Part# ASM-EAPD — E-Z-GO

Part# ASM-YAPD — Yamaha G14-G19, G22

STAINLESS

Part# ASM-CAPS — Club Car DS

Part# ASM-EAPS — E-Z-GO

Part# ASM-YAPS — Yamaha G14-G19, G22

ETIQUETTE COVER



- Diamond Plate Aluminum or High Quality Stainless Steel (Pictured)
- Great Way to Dress Up Your Cart
- Can be Powder Coated

Part# ASM-CECD — Club Car DS; Diamond

Part# ASM-CECS — Club Car DS; Stainless

Part# ASM-EECD — E-Z-Go TXT; Diamond

Part# ASM-EECS — E-Z-Go TXT; Stainless

KICK PLATES



- Protects Body from Heel Damage
- Club Car DS in Diamond Pictured

BLACK

Part# **ASM-PKPGB** — Club Car Precedent; Gas

Part# **ASM-PKPEB** — Club Car Precedent; Electric

Part# **ASM-CKPB** — Club Car DS

Part# **ASM-EKPB** — E-Z-GO TXT

Part# **ASM-RXVKPB** — E-Z-GO RXV (2-Piece Set)

Part# **ASM-YKPB** — Yamaha G14-G19

Part# **ASM-YKPB1** — Yamaha G1

Part# **ASM-YKPB2/9** — Yamaha G2-G9

Part# **ASM-YKPDRB** — Yamaha Drive

DIAMOND

Part# **ASM-PKPGD** — Club Car Precedent; Gas

Part# **ASM-PKPED** — Club Car Precedent; Electric

Part# **ASM-CKPD** — Club Car DS

Part# **ASM-EKPD** — E-Z-GO TXT

Part# **ASM-RXVKPD** — E-Z-GO RXV (2-Piece Set)

Part# **ASM-YKPD** — Yamaha G14-G19

Part# **ASM-YKPD1** — Yamaha G1

Part# **ASM-YKPD2/9** — Yamaha G2-G9

Part# **ASM-YKPD RD** — Yamaha Drive

STAINLESS

Part# **ASM-PKPGS** — Club Car Precedent; Gas

Part# **ASM-PKPES** — Club Car Precedent; Electric

Part# **ASM-CKPS** — Club Car DS

Part# **ASM-EKPSS** — E-Z-GO TXT

Part# **ASM-RXVKPS** — E-Z-GO RXV (2-Piece Set)

Part# **ASM-YKPS** — Yamaha G14-G19

Part# **ASM-YKPS1** — Yamaha G1

Part# **ASM-YKPS2/9** — Yamaha G2-G9

Part# **ASM-YKPDRS** — Yamaha Drive

ROCKER PANELS



- Stainless Mounting Hardware Included
- Available in Black (Textured or Satin), Diamond Plate, or Mirror-Finished Stainless
- Diamond Plate Pictured
- Fully Welded Endcaps

BLACK

Part# **ASM-CRPB** — Club Car DS

Part# **ASM-ERPB** — E-Z-GO TXT

Part# **ASM-WRPB** — E-Z-GO Workhorse

Part# **ASM-MRPB** — E-Z-GO Marathon

Part# **ASM-YRPB1** — Yamaha G1

Part# **ASM-YRPB2/9** — Yamaha G2-G9

Part# **ASM-YRPB** — Yamaha G14-19, G22

DIAMOND

Part# **ASM-CRPD** — Club Car DS

Part# **ASM-ERPD** — E-Z-GO TXT

Part# **ASM-WRPD** — E-Z-GO Workhorse

Part# **ASM-MRPD** — E-Z-GO Marathon

Part# **ASM-YRPD1** — Yamaha G1

Part# **ASM-YRPD2/9** — Yamaha G2-G9

Part# **ASM-YRPD** — Yamaha G14-19, G22

STAINLESS

Part# **ASM-CRPS** — Club Car DS

Part# **ASM-ERPS** — E-Z-GO TXT

Part# **ASM-WRPS** — E-Z-GO Workhorse

Part# **ASM-MRPS** — E-Z-GO Marathon

Part# **ASM-YRPS1** — Yamaha G1

Part# **ASM-YRPS2/9** — Yamaha G2-G9

Part# **ASM-YRPS** — Yamaha G14-19, G22

DIAMOND FLOOR COVER

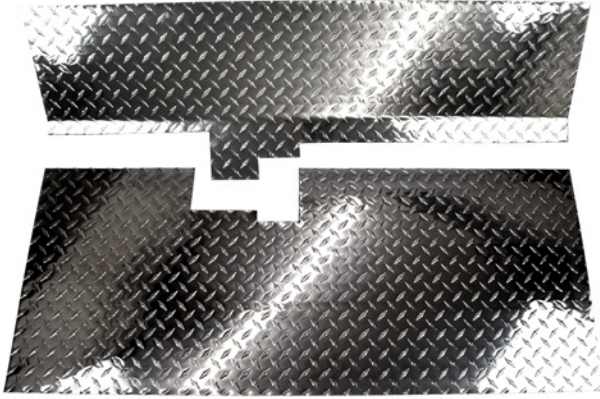

- Club Car DS Floor Cover Pictured
- Easily Rivets Over Existing Floor
- All Hardware Included
- Great Way to Dress Up Your Cart

BLACK

Part# ASM-PFLCB — Club Car Precedent

Part# ASM-CFLCB — Club Car DS

Part# ASM-EFLCB — E-Z-GO TXT

Part# ASM-RXVFLCB — E-Z-GO RXV

Part# ASM-YFLCB — Yamaha G14-G19/G22

Part# ASM-YFLCBDR — Yamaha Drive

DIAMOND

Part# ASM-PFLCD — Club Car Precedent

Part# ASM-CFLCD — Club Car DS

Part# ASM-EFLCD — E-Z-GO TXT

Part# ASM-RXVFLCD — E-Z-GO RXV

Part# ASM-YFLCD — Yamaha G14-G19/G22

Part# ASM-YFLCDDR — Yamaha Drive

FAUX EXHAUST PIPES



- Rectangular (Top) or Oblong (Bottom)
- For Club Car or E-Z-GO

Part# ASM-FTPR — Rectangular

Part# ASM-FTPO — Oblong

NAME PLATE



- Stock Messages: "Club Car" & "E-Z-GO" (Billet Only)

BILLET

Part# ASM-CBNP — Club Car

Part# ASM-EBNP — E-Z-GO TXT

DIAMOND

Part# ASM-PNPD — Club Car Precedent

Part# ASM-CNPD — Club Car DS

Part# ASM-ENPD — E-Z-GO

STAINLESS

Part# ASM-PNPS — Club Car Precedent

Part# ASM-CNPS — Club Car DS

Part# ASM-ENPS — E-Z-GO

E-Z-GO TXT AXLE COVER

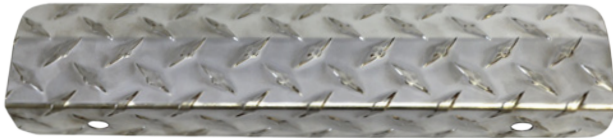

- 20 Gauge Aluminum or High Quality Stainless Steel
- Not compatible with Long Travel
- 1994-2000 Diamond Shown

1994 - 2000

Part# ASM-EACB — Black

Part# ASM-EACD — Diamond

Part# ASM-EACS — Stainless

2001 - PRESENT

Part# ASM-EACB01 — Black

Part# ASM-EACD01 — Diamond

Part# ASM-EACS01 — Stainless

SILL PLATES

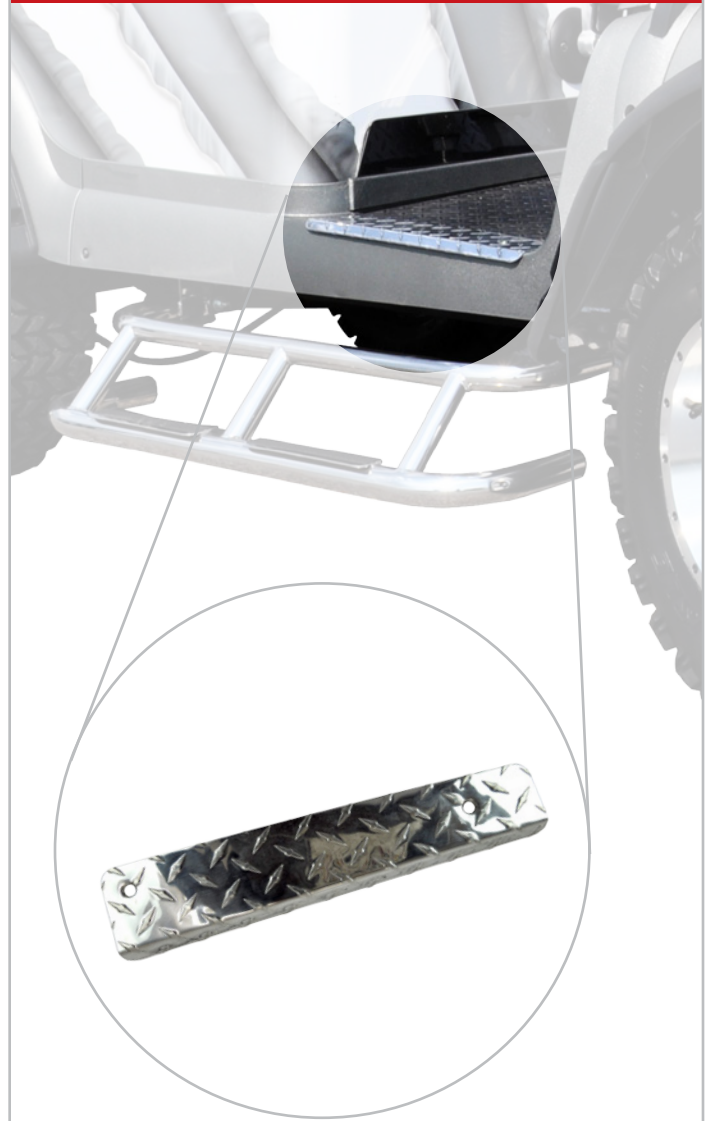

BLACK — Textured or Satin

Part# ASM-PSPB — Club Car Precedent

Part# ASM-RXVSPB — E-Z-GO RXV

Part# ASM-YSPBDR — Yamaha Drive

DIAMOND

Part# ASM-PSPD — Club Car Precedent

Part# ASM-RXVSPD — E-Z-GO RXV

Part# ASM-YSPDDR — Yamaha Drive

STAINLESS

Part# ASM-PSPS — Club Car Precedent

Part# ASM-RXVSPS — E-Z-GO RXV

Part# ASM-YSPSDR — Yamaha Drive



BATTERIES & MAINTENANCE

BATTERY CHARGE METER



- Keeps Track of Battery Life

36V

Part# ASM-BCM36

48V

Part# ASM-BCM48

VOLTAGE REDUCER



- Extends Battery Life & Protects Your New Lights or Radio

36V

Part# ASM-VR36VR

48V

Part# ASM-VR48VR

BATTERY TRAY



- Replaces OEM Tray
- Also available in aluminum

E-Z-GO TXT (Pictured)

Part# ASM-BT

E-Z-GO RXV

Part# ASM-RXVBT

LESTER LINKS SERIES BATTERY CHARGER



- Advanced Microprocessor Control w/ Precise Charging & Termination Algorithms
- Wet & Seated Charge Profiles
- Field Selectable
- Storage/Refresh Mode
- Encapsulated Controller
- Charger Protection, Includes Voltage Mismatch, Reverse Polarity & Short Circuit
- Two-Year Manufacturer Warranty

36V

Part# ASM-BC36V — 36V

Part# ASM-BC36VDS — 36V; Club Car DS

Part# ASM-BC36VTXT — 36V; E-Z-Go TXT

48V

Part# ASM-BC48V — 48V

Part# ASM-BC48VDS — 48V; Club Car DS

Part# ASM-BC48VPRECEDENT — 48V; Club Car Precedent

Part# ASM-BC48RXV — 48V; E-Z-Go RXV

Part# ASM-BC48Y — 48V; Yamaha

REAR DISC BRAKES



- More Parking Torque & Stopping Power; Longer Pad Life

CLUB CAR DS

Part# ASM-CRDB — Lifted or Non-Lifted

E-Z-GO TXT

Part# ASM-ERBD — Gas or Electric

FRONT LEAF SPRINGS



CLUB CAR PRECEDENT

Part# ASM-CFLS

CLUB CAR DS

Part# ASM-CFLS

YAMAHA DRIVE

Part# ASM-CFLS

ENGINE MAINTENANCE KITS

CLUB CAR PRECEDENT 2014 - PRESENT



- Includes Spark Plugs, Fuel Filter, Oil Filter, & Air Filter

Part# ASM-ETK03

CLUB CAR DS 1984 - 1991

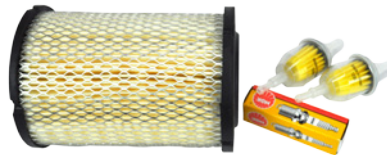

- Includes Spark Plugs, Fuel Filter, & Air Filter

Part# ASM-ETK01

CLUB CAR DS 1992 - PRESENT



- Includes Spark Plugs, Fuel Filter, Oil Filter, & Air Filter

Part# ASM-ETK02

E-Z-GO TXT 1994 - 2005



- Includes Spark Plugs, Fuel Filter, & Air Filter

Part# ASM-ETK04

E-Z-GO TXT 2005 - PRESENT



- Includes Spark Plugs, Fuel Filter, & Air Filter

Part# ASM-ETK05

E-Z-GO RXV 2008 - PRESENT



- Includes Spark Plugs, Fuel Filter, Oil Filter, & Air Filter

Part# ASM-ETK06

HEAVY DUTY SPRINGS



- Sold in Sets of 2
- Recommended for Carts with Rear Seat Kits or Cargo Boxes
- Adds Additional Support
- Increases Carrying Capacity

Part# ASM-PHDS — Club Car Precedent (Lifted); Includes New Bushings

Part# ASM-PHDSNL — Club Car Precedent (Non-Lifted); Includes New Bushings

Part# ASM-CHDS — Club Car DS; Includes New Bushings

Part# ASM-EHDS — E-Z-GO TXT; Includes New Bushings

Part# ASM-RXVHDS — E-Z-GO RXV; Includes New Bushings

36V BATTERY CABLES



- Club Car DS Pictured

Part# ASM-PBC36V — Club Car Precedent

Part# ASM-CBC36V — Club Car DS

Part# ASM-EBC36V — E-Z-GO TXT

Part# ASM-RXVBC36V — E-Z-GO RXV

Part# ASM-YBC36V — Yamaha G14-G19

Part# ASM-YDBC36V — Yamaha Drive

48V BATTERY CABLES



- E-Z-GO TXT Pictured

Part# ASM-PBC48V — Club Car Precedent

Part# ASM-CBC48V — Club Car DS

Part# ASM-EBC48V — E-Z-GO TXT

Part# ASM-RXVBC48V — E-Z-GO RXV

Part# ASM-YBC48V — Yamaha G14-G19

Part# ASM-YDBC48V — Yamaha Drive

BUSHINGS, BALL JOINTS, & HARDWARE

POLYURETHANE 1" TOP HAT BUSHINGS



Set of 4

POLYURETHANE 1 1/8" TOP HAT BUSHINGS



- For Yamaha A-Arm Lift Kits (G2, G9, G14, G16, and G19)

Set of 4

POLYURETHANE SPRING BUSHINGS



- Fits between lower control arm & leaf spring
- Club Car and Yamaha Drive A-Arm Lift Kits

Set of 8

1/2" BALL JOINT



- For Precedent A-Arm Lift Kits
- Zinc-Coated & Teflon-Lined
- Includes 1 Jam Nut

Part# ASM-PBJ

5/8" BALL JOINT



- All Sports Heavy Duty Lifts
- For Precedent Club Car Super Sport, Yamaha Drive A-Arm, or All Sports Long Travel Lift Kits
- Zinc-Coated & Teflon-Lined
- Includes 1 Jam Nut

Part # ASM-BJ

BALL JOINT ADAPTERS



- For Club Car Super Sport, Club Car A-Arm, Yamaha Drive, & All Sports Long Travel Lift Kits. Works with All Sports Lift Kits ONLY. Aluminum Construction.

Set of 4

BRONZE 1" BUSHING



Set of 4

1/2" SOCKET CAP KING PIN BOLTS



- Precedent A-Arm or Club Car 10" A-Arm; Works with All Sports Lift Kits ONLY
- Steel Construction & Zinc Coated; Sold in Set of 4

Set of 4

3/8" x 1" HEX BOLTS



- Zinc Coated, Grade 8
- Club Car Super Sports or Long Travel Lift Kits; Works With All Sport Lift Kits
- Sold in Set of 4

Set of 4

PRECEDENT A-ARM FRONT NAME PLATE



- Laser Cut with All Sports Logo
- Powder Coated Black (Standard)
- Stainless Steel Backing Plate

Set of 4

REPLACEMENT PARTS



When you buy an All Sports product, you buy it straight from the manufacturer, and we're ready and willing to provide you with any replacement parts you might need. If you need a replacement part, call us today!



All Sports Manufacturing, Inc.

allsportsliftkits.com

(866) 291-5244 ▪ LOCAL: (850) 477-5244

3361 Copter Rd. Pensacola, FL 32514